

Standard CMMISM Appraisal Method for Process Improvement (SCAMPISM), Version 1.1: Method Definition Document

Members of the Assessment Method Integrated Team

December 2001

HANDBOOK
CMU/SEI-2001-HB-001



CarnegieMellon
Software Engineering Institute

Pittsburgh, PA 15213-3890

Standard CMMISM Appraisal Method for Process Improvement (SCAMPISM), Version 1.1: Method Definition Document

CMU/SEI-2001-HB-001

Members of the Assessment Method Integrated Team

December 2001

CMM IntegrationSM Project

Unlimited distribution subject to the copyright.

This report was prepared for the

SEI Joint Program Office
HQ ESC/DIB
5 Eglin Street
Hanscom AFB, MA 01731-2116

The ideas and findings in this report should not be construed as an official DoD position. It is published in the interest of scientific and technical information exchange.

FOR THE COMMANDER

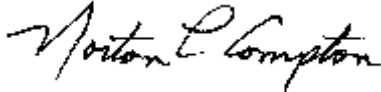

Norton L. Compton, Lt Col, USAF
SEI Joint Program Office

This work is sponsored by the U.S. Department of Defense. The Software Engineering Institute is a federally funded research and development center sponsored by the U.S. Department of Defense.

Copyright 2001 by Carnegie Mellon University.

NO WARRANTY

THIS CARNEGIE MELLON UNIVERSITY AND SOFTWARE ENGINEERING INSTITUTE MATERIAL IS FURNISHED ON AN "AS-IS" BASIS. CARNEGIE MELLON UNIVERSITY MAKES NO WARRANTIES OF ANY KIND, EITHER EXPRESSED OR IMPLIED, AS TO ANY MATTER INCLUDING, BUT NOT LIMITED TO, WARRANTY OF FITNESS FOR PURPOSE OR MERCHANTABILITY, EXCLUSIVITY, OR RESULTS OBTAINED FROM USE OF THE MATERIAL. CARNEGIE MELLON UNIVERSITY DOES NOT MAKE ANY WARRANTY OF ANY KIND WITH RESPECT TO FREEDOM FROM PATENT, TRADEMARK, OR COPYRIGHT INFRINGEMENT.

Use of any trademarks in this report is not intended in any way to infringe on the rights of the trademark holder.

Internal use. Permission to reproduce this document and to prepare derivative works from this document for internal use is granted, provided the copyright and "No Warranty" statements are included with all reproductions and derivative works.

External use. Requests for permission to reproduce this document or prepare derivative works of this document for external and commercial use should be addressed to the SEI Licensing Agent.

This work was created in the performance of Federal Government Contract Number F19628-00-C-0003 with Carnegie Mellon University for the operation of the Software Engineering Institute, a federally funded research and development center. The Government of the United States has a royalty-free government-purpose license to use, duplicate, or disclose the work, in whole or in part and in any manner, and to have or permit others to do so, for government purposes pursuant to the copyright license under the clause at 252.227-7013.

For information about purchasing paper copies of SEI reports, please visit the publications portion of our Web site (<http://www.sei.cmu.edu/publications/pubweb.html>).

Table of Contents

Abstract	xi
Part I: Overview	I-1
About This Document	3
Document Outline	3
Audiences for This Document	5
How to Use This Document	5
Feedback Information	7
Executive Summary	9
What is SCAMPI?	9
Core Concepts and Approach	10
SCAMPI Method Overview	15
Method Context	15
Method Objectives and Characteristics	15
Modes of Usage	16
Method Performance	18
Method Concepts	20
Method Assumptions and Design Principles	20
Verification vs. Discovery	22

Focused Investigation	23
Practice Implementation Indicators	24
Data Collection, Rating, and Reporting	26
Instruments and Tools	29
Effective Team Practices	31
Method Description	32
Part II: Process Definitions	II-2
1.1 Analyze Requirements	II-4
1.1.1 Determine Appraisal Objectives	II-7
1.1.2 Determine Appraisal Constraints	II-9
1.1.3 Determine Appraisal Scope	II-11
1.1.4 Determine Outputs	II-15
1.2 Develop Appraisal Plan	II-20
1.2.1 Tailor Method	II-23
1.2.2 Identify Needed Resources	II-25
1.2.3 Determine Cost and Schedule	II-27
1.2.4 Plan and Manage Logistics	II-29
1.2.5 Document and Manage Risks	II-30
1.2.6 Obtain Commitment to Appraisal Plan	II-31
1.3 Select and Prepare Team	II-34
1.3.1 Identify Team Leader	II-37

1.3.2	Select Team Members	II-39
1.3.3	Prepare Team	II-41
1.4	Obtain and Analyze Initial Objective Evidence	II-48
1.4.1	Prepare Participants	II-51
1.4.2	Administer Instruments	II-53
1.4.3	Obtain Initial Objective Evidence	II-55
1.4.4	Inventory Objective Evidence	II-57
1.5	Prepare for Collection of Objective Evidence	II-60
1.5.1	Perform Readiness Review	II-63
1.5.2	Prepare Data Collection Plan	II-65
1.5.3	Replan Data Collection	II-69
2.1	Examine Objective Evidence	II-72
2.1.1	Examine Objective Evidence from Instruments	II-75
2.1.2	Examine Objective Evidence from Presentations	II-77
2.1.3	Examine Objective Evidence from Documents	II-79
2.1.4	Examine Objective Evidence from Interviews	II-81
2.2	Verify and Validate Objective Evidence	II-86
2.2.1	Verify Objective Evidence	II-89

2.2.2 Characterize Implementation of Model Practices	II-91
2.2.3 Validate Practice Implementation Gaps	II-95
2.3 Document Objective Evidence	II-100
2.3.1 Take/Review/Tag Notes	II-103
2.3.2 Record Presence/Absence of Objective Evidence	II-105
2.3.3 Document Practice Implementation Gaps	II-107
2.3.4 Review and Update the Data Collection Plan	II-109
2.4 Generate Appraisal Results	II-112
2.4.1 Derive Findings and Rate Goals	II-115
2.4.2a Determine Process Area Capability Level	II-117
2.4.2b Determine Satisfaction of Process Areas	II-119
2.4.3a Determine Capability Profile	II-120
2.4.3b Determine Maturity Level	II-121
2.4.4 Document Appraisal Results	II-122
3.1 Deliver Appraisal Results	II-124
3.1.1 Present Final Findings	II-127
3.1.2 Conduct Executive Session(s)	II-131
3.1.3 Plan for Next Steps	II-133

3.2 Package and Archive Appraisal Assets	II-136
3.2.1 Collect Lessons Learned	II-139
3.2.2 Generate Appraisal Record	II-141
3.2.3 Provide Appraisal Feedback to CMMI Steward	II-143
3.2.4 Archive and/or Dispose of Key Artifacts	II-144
Part III: Appendices, References, and Glossary	III-1
Appendix A: Appraisal Disclosure Statement	III-3
Appendix B: The Role of Practice Implementation Indicators in Verifying Practice Implementation	III-5
Appendix C: Focused Investigation Elaboration and Guidance	III-13
Appendix D: ARC/MDD Traceability Table	III-15
References/Bibliography	III-29
Glossary	III-31

List of Figures

Figure I-1: Example of PII Use	I-26
Figure I-2: SCAMPI Rating Process	I-27
Figure I-3: Process Flows, Plan and Prepare Processes	I-38
Figure I-4: Process Flows, Conduct Appraisal Processes	I-39
Figure I-5: Process Flows, Report Results Processes	I-40
Figure I-6: Nominal Schedule for Assessment Mode	I-41
Figure I-7: Nominal Schedule for Evaluation Mode	I-42

List of Tables

Table I-1: Part I Contents	I-3
Table I-2: Part II Contents	I-4
Table I-3: Part III Contents	I-4
Table I-4: Process Definition Elements	I-6
Table I-5: Activity Description Elements	I-7
Table I-6: Essential Characteristics of the SCAMPI Method	I-16
Table I-7: SCAMPI Modes of Usage	I-17
Table I-8: Potential Targets for Appraisal Performance Improvement	I-19
Table I-9: Practice Implementation Indicator Types	I-25
Table I-10: SCAMPI Phase Summary: Plan and Prepare for Appraisal	I-35
Table I-11: SCAMPI Phase Summary: Conduct Appraisal	I-36
Table I-12: SCAMPI Phase Summary: Report Results	I-37
Table III-1: PII Types	III-8
Table III-2: A PIID Schema	III-10
Table III-3: An Example PIID	III-10
Table III-4: ARC Traceability	III-15

Abstract

The Standard CMMI Appraisal Method for Process Improvement (SCAMPISM) is designed to provide benchmark quality ratings relative to Capability Maturity Model[®] Integration (CMMISM) models. It is applicable to a wide range of appraisal usage modes, including both internal process improvement and external capability determinations. SCAMPI satisfies all of the Appraisal Requirements for CMMI (ARC) requirements for a Class A appraisal method and can support the conduct of ISO/IEC 15504 assessments.

The SCAMPI Method Definition Document describes the requirements, activities, and practices associated with each of the processes that compose the SCAMPI method. It is intended to be one of the elements of the infrastructure within which SCAMPI Lead Appraisers conduct a SCAMPI appraisal. Precise listings of required practices, parameters, and variation limits, as well as optional practices and guidance for enacting the method, are covered. An overview of the method's context, concepts, and architecture is also provided.

[®] Capability Maturity Model is registered in the U.S. Patent and Trademark Office.

SM SCAMPI, CMMI, and CMM Integration are service marks of Carnegie Mellon University.

Part I: Overview

About This Document

The Method Definition Document (MDD) describes the Standard CMMISM Appraisal Method for Process Improvement (SCAMPISM). It is intended to meet the needs of different readers. The document is divided into three major parts, each with a different level of detail, intended usage, and primary audience. The structure, audiences, and suggested use of each part of the document are described below.

Document Outline

Part I: Overview

This part of the document provides an overview of the method's context, concepts, and architecture. The reader is provided with the big picture of the method, rather than details about how to enact it. Table I-1 shows the contents of Part I.

Table I-1: Part I Contents

Section	Pages
About This Document	I-3 – I-7
Executive Summary	I-9 – I-13
SCAMPI Method Overview	I-15 – I-41

Part II: Process Definitions

This part of the document provides the definitive coverage of method requirements and detailed activities and practices associated with each of the processes that compose the SCAMPI method. Precise listings of required practices, parameters, and limits of variation allowable, as well as optional practices and guidance for enacting the method, are covered in this core part of the document. Table I-2 shows the contents of Part II.

SM CMMI, CMM Integration, and SCAMPI are service marks of Carnegie Mellon University.

Table I-2: Part II Contents

Phase	Process	Pages
1: Plan and Prepare for Appraisal	1.1 Analyze Requirements	II-3 – II-17
	1.2 Develop Appraisal Plan	II-19 – II-31
	1.3 Select and Prepare Team	II-33 – II-45
	1.4 Obtain and Analyze Initial Objective Evidence	II-47 – II-58
	1.5 Prepare for Collection of Objective Evidence	II-59 – II-69
2: Conduct Appraisal	2.1 Examine Objective Evidence	II-71 – II-84
	2.2 Verify and Validate Objective Evidence	II-85 – II-97
	2.3 Document Objective Evidence	II-99 – II-109
	2.4 Generate Appraisal Results	II-111 – II-121
3: Report Results	3.1 Deliver Appraisal Results	II-123 – II-133
	3.2 Package and Archive Appraisal Assets	II-135 – II-143

Part III: Appendices

The material contained in the appendices of this document provide further elaboration on selected topics, and are intended to supplement the material in the first two parts of the document. Rarely will someone who has not already read the first two parts read an appendix of this document. The topical elaboration and reference material available in the appendices help to provide deeper insight to an already knowledgeable reader. Table I-3 shows the contents of Part III.

Table I-3: Part III Contents

Section	Pages
Appendix A: Appraisal Disclosure Statement	III-3
Appendix B: The Role of Practice Implementation Indicators in Verifying Practice Implementation	III-5 – III-11
Appendix C: Focused Investigation Elaboration and Guidance	III-13 – III-14
Appendix D: ARC/MDD Traceability Table	III-15 – III-28
References	III-29 – III-30
Glossary	III-31 – III-39

Audiences for This Document

The MDD is primarily intended for SCAMPI Lead Appraisers authorized by the Software Engineering Institute (SEI). It is expected that these professionals meet prerequisites for knowledge and skills specified by the SEI Appraiser program (see <http://www.sei.cmu.edu/> for details), and that this document is one of the elements of the infrastructure within which they operate. They are considered the primary audience for Part II. Candidate Lead Appraisers will also use the MDD while attending training to learn about the method.

Appraisal team members (under the leadership of an authorized SCAMPI Lead Appraiser) are expected to refer to this document as a training aid. Portions of the document may also be used as work aids during the conduct of an appraisal. Potential appraisal team members can use the MDD to build their knowledge base for future participation in an appraisal.

Finally, the larger set of stakeholders for the conduct of any given appraisal are also in the targeted audience for the document, particularly for Part I. These stakeholders include:

- appraisal sponsors—leaders who sponsor appraisals to meet business needs
- Process Group members—process improvement specialists who need to understand the method, and perhaps help others to gain familiarity
- other interested parties who wish to have deeper insight into the methodology for purposes such as ensuring that they have an informed basis for interpreting SCAMPI outputs or making comparisons among similar methodologies

How to Use This Document

Part I

It is expected that every member of the audience for this document will find value in Part I. The two primary sections in this part are the Executive Summary and the Method Overview.

The **Executive Summary** is intended to provide high-level information about what SCAMPI is, and does not require extensive knowledge of appraisals. This portion of the document may be excerpted and provided to a more casual reader or a stakeholder in need of general information to support their decision to conduct an appraisal.

The **Method Overview** section provides more comprehensive coverage of SCAMPI, and can be used to begin building a base of knowledge for readers who have need of more detailed information. Appraisal sponsors wanting more than the summary view described above will want to read this section. Every prospective SCAMPI team leader and team member is expected to read this section of the document, to ensure that they have the big picture before study of the detailed methodology begins.

Part II

People who will enact an appraisal are expected to read the second part of the document. Members of this audience need to know how to enact the method, not just what the method is. Part II is divided into Process Definitions, which are in turn divided into Activity Descriptions. Each Activity Description delineates Required Practices, Parameters and Limits, Optional Practices, and Implementation Guidance.

There are **eleven processes** contained in SCAMPI. The processes (as defined) support a variety of orderings and enactments to facilitate a variety of usage modes for SCAMPI. The temporal flow, as well as the flow of inputs and outputs among the processes, is described in the Method Overview section. The Process Definitions are not intended to provide a start-to-finish view of SCAMPI. Rather, these sections provide detailed definitions of processes and activities that are invoked according to the appraisal plan created by the appraisal team leader.

Each of the Process Definitions begins with a **three-page overview** of the process. Every process is defined by information contained in the elements shown in Table I-4.

Table I-4: Process Definition Elements

Element	Description
Purpose	A brief summary of what is accomplished by enacting the process
Entry Criteria	Conditions that must be met before enacting the process
Inputs	Artifacts or information needed to enact the process
Activities	The set of actions which, in combination, make up the process
Outputs	Artifacts and assets that result from enacting the process
Outcome	Any change in important conditions or artifacts that results from enacting the process
Exit Criteria	Conditions to be met before the process can be considered complete
Key Points	A summary of the most notable events associated with the process
Tools and Techniques	Work aids commonly used in enacting the process
Metrics	Useful measures that support the process enactment, or future enactments
Verification and Validation	Techniques to verify and/or validate the enactment of the process
Records	Information to be retained for future use
Tailoring	Brief discussion of key tailoring options (not an exhaustive list)
Interfaces with Other Processes	Discussion of how the process interacts with other processes in the method
Summary of Activities	A narrative summary of the set of activities

Following the three pages of introductory material, each activity that is a part of the process is briefly summarized to orient the reader to the scope of the activity. Each **Activity Description** includes the elements shown in Table I-5.

Table I-5: Activity Description Elements

Element	Description
Required Practices	A listing of practices that must be implemented to consider the enactment a valid SCAMPI
Parameters and Limits	Acceptable limits for things that are allowed to vary, and acceptable limits for things under the discretion of the appraisal team leader
Optional Practices	Actions that reflect good practice but are not required
Implementation Guidance	Narrative description of advice or things to consider in performing the activity

Complete and unambiguous descriptions of the method processes and activities are provided in this part of the document. In combination with the training materials and work aids that compose the CMMI Steward's appraiser program, this information provides a firm basis for standardization (within reasonable limits) of the practice of Process Appraisals.

Part III

The appendices of the document provide detailed coverage of special topics as well as reference material. Readers knowledgeable in SCAMPI are expected to read these sections for further understanding.

Feedback Information

We are very interested in your ideas for improving this document. See the CMMI Web site for information on how to provide feedback: <<http://www.sei.cmu.edu/cmmi/products/change-requests.html>>.

If you have questions, send an email to cmmi-comments@sei.cmu.edu.

Executive Summary

What is SCAMPI?

The Standard CMMI Appraisal Method for Process Improvement (SCAMPI) is designed to provide benchmark quality ratings relative to Capability Maturity Model Integration (CMMISM) models. It is applicable to a wide range of appraisal usage modes, including both internal process improvement and external capability determinations. SCAMPI satisfies all of the Appraisal Requirements for CMMI (ARC) requirements for a Class A appraisal method and can support the conduct of ISO/IEC 15504 assessments.

SCAMPI V1.1 enables a sponsor to

- gain insight into an organization's engineering capability by identifying the strengths and weaknesses of its current processes
- relate these strengths and weaknesses to the CMMI model
- prioritize improvement plans
- focus on improvements (correct weaknesses that generate risks) that are most beneficial to the organization given its current level of organizational maturity or process capabilities
- derive capability level ratings as well as a maturity level rating
- identify development/acquisition risks relative to capability/maturity determinations

As a Class A appraisal method, SCAMPI is an appropriate tool for benchmarking. Sponsors who want to compare an organization's process improvement achievements with other organizations in the industry may have a maturity level determined as part of the appraisal process. Decisions made on the basis of maturity level ratings are only valid if the ratings are based on known criteria. Consequently, contextual information—organizational scope, CMMI model scope, appraisal method type, the identity of the Lead Appraiser and the team—are items for which criteria and guidance are provided within the method to ensure a consistent interpretation within the community. Benchmarking can only be valid when there is a consistent basis for establishing the benchmarks. The SEI maintains industry aggregates for appraisal results. These data are reported in industry maturity profiles gathered from organizations that have performed appraisals since 1987. The profile is based upon appraisal data provided by SEI-trained professionals, and is updated twice annually.

SM CMMI is a service mark of Carnegie Mellon University.

As the CMMI Steward, the SEI supports the SCAMPI method and operates an authorization program for SCAMPI Lead Appraisers. Additional details can be found at <http://www.sei.cmu.edu>.

Core Concepts and Approach

SCAMPI V1.1, as a benchmarking appraisal method, relies upon an aggregation of evidence that is collected via instruments, presentations, documents, and interviews. These four sources of data feed an “information-processing engine” whose parts are made up of a series of data transformations. The appraisal team observes, hears, and reads information that is transformed first into notes, and then into statements of practice implementation gaps or strengths (where appropriate), and then into preliminary findings. These are validated by the organizational unit before they become final findings. The critical concept is that these transformations are applied to data reflecting the enacted processes in the organizational unit and the CMMI reference model, and this forms the basis for ratings and other appraisal results.

Planning is absolutely critical to the execution of SCAMPI V1.1. All phase and process activities briefly discussed below derive from a well-articulated plan developed by the qualified Lead Appraiser, in concert with members of the appraised organization and the appraisal sponsor.

SCAMPI V1.1 Methodology

SCAMPI consists of three phases and eleven essential processes, as was shown in Table I-2. Each phase is described in detail below.

Phase 1: Plan and Prepare for Appraisal

The sponsor’s objectives for performing SCAMPI are determined in phase 1, process 1.1, Analyze Requirements. All other planning, preparation, execution, and reporting of results proceed from this initial activity according to the phase and processes outlined. Because of the significant investment and logistical planning involved, considerable iteration and refinement of planning activities should be expected in phase 1. With each subsequent phase, the amount of iteration will decrease as data are collected, analyzed, refined, and translated into findings of significance relative to the model.

A team of experienced and trained personnel performs a SCAMPI over a period of time negotiated by the sponsor and the team leader. The scope of the organization to be appraised (actual projects or programs that will participate), as well as the scope within the CMMI model (process areas), must be defined and agreed to. The scope of the organization and model provides the basis upon which to estimate personnel time commitments, logistical costs (e.g., travel), and overall costs to the appraised organization and to the sponsoring organization.

Before the appraisal begins, members of the appraised organization typically prepare objective evidence. Objective evidence consists of qualitative or quantitative information, records, or statements of fact pertaining to the characteristics of an item or service or to the existence and implementation of a process element. It is based on observation, measurement, or test, and can be verified. During an on-site period, the appraisal team verifies and validates the objective evidence provided by the appraised organization to identify strengths and weaknesses relative to the CMMI reference model. The information-processing engine is thus fueled by the objective evidence already available, saving the appraisal team the time and effort of a “discovery” process.

This preparation by the appraised organization is critical to the efficient execution of a SCAMPI appraisal. Analysis of preliminary objective evidence provided by the appraised organization plays a critical role in setting the stage for the appraisal execution. If substantial data are missing at this point, subsequent appraisal activities can be delayed or even cancelled if the judgment is made that continuing appraisal activities will not be sufficient to make up for the deficiency.

The collection of objective evidence by the appraised organization in advance of the appraisal not only improves appraisal team efficiency, but also offers several other benefits to the organization:

- improved accuracy in appraisal results delivered by external appraisal teams (i.e., clear understanding of implemented processes, strengths, and weaknesses)
- detailed understanding of how each process instance has implemented appraisal reference model practices, and the degree of compliance and tailoring of organizational standard processes
- facilities for monitoring process compliance and process improvement progress
- residual appraisal assets that can be reused on subsequent appraisals, minimizing the effort necessary for preparation

Phase 2: Conduct Appraisal

In phase 2, the appraisal team focuses on collecting data from the appraised organization to judge the extent to which the model is implemented. Integral to this approach is the concept of “coverage,” which implies (a) the collection of sufficient data for each model component within the CMMI reference model scope selected by the sponsor, and (b) obtaining a representative sample of ongoing processes (spanning the life-cycle phases that the appraised organization is using in the development and delivery of its products and services). For a benchmarking appraisal methodology, this means collecting data and information on all the reference model practices for each process instantiation being appraised within the organizational unit. The data collection plan developed in phase 1 undergoes continuous iteration and refinement until sufficient coverage is achieved.

Upon determining that sufficient coverage of the reference model and organizational unit has been obtained, appraisal findings and ratings may be generated. Goal ratings are determined within each process area, which collectively can be used to determine a capability level rating for the individual process areas, as well as a process maturity rating for the organizational unit.

Phase III: Report Results

In phase III, the appraisal team provides the findings and ratings as appraisal results to the appraisal sponsor and the organization. These appraisal results become part of the appraisal record, which becomes protected data according to the desires of the sponsoring organization and the appraised organization. The level of protection and the plan for the disposition of appraisal materials and data is determined in phase I in collaboration with the sponsor. The agreed-to appraisal record is also forwarded to the CMMI Steward. The Steward adds it to a confidential database for summarization into overall community maturity and capability level profiles, which are made available to the community on a semiannual basis.

SCAMPI Tailoring

Successful application of SCAMPI V1.1 relies upon adjusting the parameters of the method to the needs of the organization and to the objectives and constraints of the sponsor's organization.

The sponsor's objectives largely influence tailoring decisions. The CMMI model scope and representation (staged or continuous), the size of the organizational unit, the number and size of sampled projects, the size of the appraisal team, and the number of interviews greatly influence things such as preparation time, time on site, and monetary costs, and so are also major factors when choosing tailoring options. All tailoring decisions must be documented in the appraisal plan.

Tailoring should not exceed the acceptable limits allowed by the appraisal method. The SCAMPI Lead Appraiser is responsible for ensuring that the requirements of the method are satisfied. Tailoring the method too severely could result in the failure to satisfy method requirements, the inability to obtain sufficient data for generation of appraisal findings or ratings, or the failure to meet the criteria necessary for recognition as a SCAMPI (ARC Class A) appraisal.

Time Frame and Personnel Requirements

A nominal time frame for conducting a SCAMPI appraisal is 3 months, including planning, preparation, and execution. The follow-on activities implicit with a full cycle of appraisal to re-appraisal would include time for creating an action plan and 18 to 24 months for implementation, with a re-appraisal occurring in the latter 6 months of that period. (The time estimates given here refer to calendar duration rather than person-months of effort.)

Personnel needed to participate in activities or perform tasks in a SCAMPI appraisal include the sponsor, the appraisal team leader, the Organizational Unit Coordinator (OUC), the selected participants, and appraisal team members. Their time commitments will vary a great deal depending on the specific parameters of the appraisal (e.g., organizational scope) and their role. Typically, appraisal participants can expect to spend one to three hours each to provide objective evidence to the team and attend validation sessions. On the other extreme, the OUC may spend as much as three weeks of full time effort helping the team and the organization to prepare for and conduct the appraisal. Experienced Lead Appraisers will provide effort estimates corresponding to the set of tailoring options they prefer to use in conducting a SCAMPI appraisal.

SCAMPI Method Overview

This section provides an overview of the underlying principles and concepts of the SCAMPI method. Readers of the SCAMPI MDD should become familiar with this material prior to reading the process descriptions in Part II of this document, where the method requirements and tailoring options are defined. This overview is primarily targeted at appraisal team leaders and appraisal team members who will be performing SCAMPI appraisals. Additional audiences might include appraisal sponsors or process improvement professionals interested in understanding SCAMPI features and the results that can be expected.

Method Context

The SCAMPI appraisal method is used to identify strengths, weaknesses, and ratings relative to CMMI reference models. It incorporates best practices found successful in the appraisal community, and is based on the features of several legacy appraisal methods, including

- CMM-Based Appraisal for Internal Process Improvement (CBA IPI) V1.1 [Dunaway 96b].
- Electronic Industries Alliance/Interim Standard (EIA/IS) 731.2 Appraisal Method [EIA 98b].
- Software Capability Evaluation (SCE) V3.0 Method Description [Byrnes 96]
- Software Development Capability Evaluation (SDCE) [AFMC 94]
- FAA Appraisal Method (FAM) [Ibrahim 99]

SCAMPI satisfies the Appraisal Requirements for CMMI (ARC) V1.1 [SEI 01a] and is a Class A appraisal method.

Method Objectives and Characteristics

The SCAMPI method has the following primary objectives:

- Provide a common, integrated appraisal method capable of supporting appraisals in the context of internal process improvement, supplier selection, and process monitoring (see “Modes of Usage”).
- Provide an efficient appraisal method capable of being implemented within reasonable performance constraints (see “Method Performance”).

The SCAMPI method is also designed to prioritize and satisfy certain essential characteristics, which were obtained via community feedback and are summarized in Table I-6. These have been used as the rationale for key method architecture and design decisions, which are described in this overview and throughout the MDD.

Table I-6: Essential Characteristics of the SCAMPI Method

Characteristic	Explanation
Accuracy	Ratings are truly reflective of the organization’s maturity/capability, reflect the reference model, and can be used for comparison across organizations. Appraisal results reflect the strengths and weaknesses of the appraised organization (i.e., no significant strengths and weaknesses are left undiscovered).
Repeatability	Ratings and findings of an appraisal are likely to be consistent with those of another independent appraisal conducted under comparable conditions (i.e., another appraisal of identical scope will produce consistent results).
Cost/Resource Effectiveness	The appraisal method is efficient in terms of person-hours spent planning, preparing, and executing an appraisal. The method takes account of the organizational investment in obtaining the appraisal results, including the resources of the host organization, the impact on appraised projects, and the appraisal team.
Meaningfulness of Results	Appraisal results are useful to the appraisal sponsor in supporting decision making. This may include application of the appraisal results in the context of internal process improvement, supplier selection, or process monitoring.
ARC Compliance	SCAMPI is a Class A method and complies with all ARC requirements.

Modes of Usage

As used in the CMMI Product Suite materials, an appraisal is an examination of one or more processes by a trained team of professionals using an appraisal reference model as the basis for determining strengths and weaknesses. An appraisal is typically conducted in the context of process improvement or capability evaluation. The term “appraisal” is a generic term used throughout the CMMI Product Suite to describe applications in these contexts, traditionally known as assessments and evaluations.

The basic difference between an assessment and an evaluation is that an assessment is an appraisal that an organization does to and for itself for the purposes of process improvement. Assessments provide internal motivation for organizations to initiate or continue process improvement programs. An evaluation is an appraisal in which an external group comes into an

organization and examines its processes as input to a decision regarding future business. Evaluations are typically externally imposed motivation for organizations to undertake process improvement.

Historically, assessments and evaluations have been performed using separate, but similar, method descriptions, training, infrastructure, and assets. With version 1.1 of the CMMI Product Suite, these are now combined into a single, integrated appraisal methodology. Apart from this section of the MDD, the terms assessment and evaluation are not used; the more general term “appraisal” is used throughout to encourage the recognition of a single integrated method. Concepts from legacy assessment and evaluation methods are borrowed from liberally in the SCAMPI MDD, and representative experts in these methods contributed as core members of the ARC/MDD product development team. It is expected that users familiar with one or more of those legacy methods will be able to identify features that will help ease their transition to the SCAMPI method.

As an ARC Class A method, SCAMPI is a benchmarking-oriented method suitable for generating ratings. SCAMPI appraisals can be performed in three modes of usage, as depicted in Table I-7. While many of the SCAMPI features are common across all usage modes (e.g., identification of strengths, weaknesses, and ratings), there are differences in motivation and intent that can result in some expected method differences in these usage modes. The method may be tailored significantly to meet the business objectives of the appraisal sponsor.

Table I-7: SCAMPI Modes of Usage

Usage Mode	Description
Internal Process Improvement	Organizations use appraisals to appraise internal processes, generally to either baseline their capability/maturity level(s), to establish or update a process improvement program, or to measure progress in implementing such a program. Applications include measuring process improvement progress, conducting process audits, focusing on specific domains or product lines, appraising specific projects, and preparing for external customer-led appraisals. In this manner, SCAMPI appraisals supplement other tools for implementing process improvement activities.
Supplier Selection	Appraisal results are used as a high-value discriminator to select suppliers. The results are used in characterizing the process-related risk of awarding a contract to a supplier. The appraisal results are typically only one criterion among many used to select suppliers. Results are often used as a baseline in subsequent process monitoring with the selected supplier.

Usage Mode	Description
Process Monitoring	Appraisal methods are also used in monitoring processes (for example, after contract award, by serving as input for an incentive/award fee decision or a risk management plan). The appraisal results are used to help the sponsoring organization tailor its contract or process monitoring efforts by allowing it to prioritize efforts based on the observed strengths and weaknesses of the supplying organization's processes. This usage mode focuses on a long-term teaming relationship between the sponsoring organization and the development organization (buyer and supplier).

Where appropriate, differences in the method requirements, tailoring, or recommended implementation applicable to these usage modes are discussed in process descriptions and activities provided in Part II. These differences occur most significantly in the planning processes (e.g., appraisal objectives, sponsorship, appraisal planning, selection of participants, preparation) and reporting processes (e.g., reporting of appraisal results, use of appraisal results for decision-making, and follow-on activities).

Note that the SCAMPI method boundary is expressed in terms of enactment of the appraisal method, including reporting of appraisal results, but does not address the usage of those results in the sponsor's business context. For example, the use of appraisal results to identify acquisition risks for a supplier source selection is beyond the scope of the method. These concepts are better described in other documentation specific to those business contexts, such as acquisition regulations, standards, and processes.

Method Performance

Performing appraisals efficiently involves minimizing the use of resources and the impact on appraisal teams and appraised organizations, while maintaining the essential method characteristics that ensure the high degree of accuracy required for an effective benchmarking appraisal method. The significantly larger size of the CMMI models relative to legacy source models makes this an even greater challenge.

Method performance during the on-site period was an influential design driver that directly resulted in many of the SCAMPI features. The MDD contains many recommendations on proven, effective practices that contribute positively to efficient appraisals, although many of these may not be strict requirements of the method. However, the appraisal method is only part of the solution for efficient and cost-effective benchmarking appraisals capable of satisfying all appraisal objectives. Appraisal efficiency must also be a commitment shared among appraisal sponsors, appraised organizations, and appraisal teams.

Several means were used to identify targets for appraisal performance improvement, including analysis of CBA IPI results [Dunaway 00], efficiency features from other appraisal meth-

ods, CMMI pilot appraisals, and improvement suggestions and best practices solicited from the Lead Appraiser community. Ideas were grouped, analyzed, and prioritized for potential benefit to method performance improvement. Among the areas identified as potential targets for performance improvement were the following:

Table I-8: Potential Targets for Appraisal Performance Improvement

Performance Improvement Topic	Summary Description and Examples
Prework	Thorough appraisal planning. Greater organizational readiness. Pre-on-site data review.
Focused Investigation	Focus the scope of investigation and follow-up based on documentation review and questionnaire analysis. Continually consolidate data to determine progress toward sufficient coverage. Target further investigation and interviews on specific data collection needs to optimize effort where it is needed.
Reuse	Validate results of prior appraisals. Reduce discovery of earlier, proven findings.
Observations	Reduce time spent crafting observations.
Tailoring	Provide greater clarity on mandatory, suggested, and optional features of the method.
Rating	Rate practices (e.g., implemented, partial, not implemented).
Tools	Tool support is crucial for efficient data collection, analysis, and consolidation.
Training	Just-in-time training. Use “live data” and tools for exercises.
Assets	“Look-fors,” templates, checklists.

Several of these performance improvement topics have been incorporated into the SCAMPI MDD, either as fundamental method concepts (described in “Method Concepts” below), or as recommendations and implementation options.

Since SCAMPI is suitable for benchmarking, thus requiring high confidence in ratings, thoroughness is necessary. Organizations for which (a) generation of ratings is not required, (b) the primary application is identification of strengths and weaknesses for process improvement, and (c) efficiency of appraisal resources is a primary concern may be well advised to consider alternative appraisal approaches. Their needs may be satisfied by less demanding ARC Class B or Class C methods. This is particularly true for organizations that are early in their process improvement cycle. Refer to “Requirements for CMMI Appraisal Method Class Structure” and “Requirements for CMMI Appraisal Methods” in the ARC [SEI 01a] for further discussion of these issues and for guidance in selecting an appropriate appraisal method to fit your business objectives.

Method Concepts

This section provides a description of fundamental concepts employed by the SCAMPI method. These concepts are treated here to provide readers with an overall understanding of the method prior to reading the method Process Definitions in Part II. Many of these concepts are distributed across several appraisal method processes or activities, so it is important to ensure that a common understanding is obtained to recognize the components of these concepts as they appear elsewhere in this document.

In addition to requirements of the ARC, these method concepts are derived from, and heavily influenced by, the method objectives, essential method characteristics, appraisal modes of usage, and performance objectives described above.

Method Assumptions and Design Principles

In addition to the factors just mentioned, SCAMPI features are based on certain method assumptions and design principles related to the expected use of the method. Those assumptions and principles are described below.

SCAMPI is a Class A benchmarking method.

As an ARC Class A method, SCAMPI can be used to generate ratings as benchmarks to compare maturity levels or capability levels across organizations. SCAMPI is an integrated appraisal method that can be applied in the context of internal process improvement, supplier selection, or process monitoring. As a benchmarking method, the SCAMPI emphasis is on a rigorous method capable of achieving high accuracy and reliability of appraisal results through the collection of objective evidence from multiple sources.

Goal ratings are a function of the extent to which the corresponding practices are present in the planned and implemented processes of the organization.

In the CMMI models, there is a direct relationship between goals (specific and generic) and the practices (specific and generic) that contribute toward achievement of those goals. Specific and generic goals are required model components; specific and generic practices are expected model components, in that alternative practices could be implemented that are equally effective in achieving the intent of the associated goals.

In the SCAMPI method, a fundamental premise is that satisfaction of goals can be determined only upon detailed investigation of the extent to which each corresponding practice is implemented, for each sample instance used as a basis for the appraisal (e.g., each project).

Additional information on rating goals is provided in “Data Collection, Rating, and Reporting” on page I-26.

The aggregate of objective evidence provided is used as the basis for determining practice implementation.

To make reasonable judgments regarding an organization's implemented processes relative to the CMMI models, appraisal teams base their judgments on the collection of objective evidence for each specific and generic practice applicable to process area goals within the appraisal scope.

Appraisal teams compare the objective evidence collected against the corresponding practices in the reference model. In making inferences about the extent to which practices are or are not implemented, appraisal teams draw upon the entire model document to understand the intent of the model, and use it as the basis for their decisions. This includes the required and expected model components (i.e., generic and specific goals, generic and specific practices), as well as informative material, such as model front matter, introductory text, glossary definitions, and subpractices.

Practice implementation at the organizational unit level is a function of the degree of practice implementation at the instantiation level (e.g., projects).

Practices described in the CMMI models are abstractions that are realized by their implementation within projects and organizations. The context within which the practice is applied drives the implementation. The details of the implementation, as well as the context within which the practice is implemented, are referred to as the instantiation of the process, which may occur at the organizational or project level.

An organizational unit is the part of an organization that is the focus of an appraisal. An organizational unit operates within a coherent process context and a coherent set of business objectives. It may consist of a set of related projects. (Refer to the glossary for a complete definition.)

The extent to which an organizational unit has implemented CMMI model practices can be determined only by considering, in aggregate, the extent to which those practices are implemented by instantiations of the process (i.e., each sample project considered within the appraisal scope). This, in turn, necessitates the consideration of objective evidence for each instantiation, for each model practice within the appraisal scope.

Appraisal teams are obligated to seek and consider objective evidence of multiple types in determining practice implementation and goal satisfaction.

The SCAMPI method is data oriented, in that decisions on practice implementation and rating are made based upon the aggregate of objective evidence available to the appraisal team. Multiple types of objective evidence must be considered; these are described in "Objective Evidence Sources" on page I-23. Artifacts indicative of practice implementation are a re-

quirement of the SCAMPI method. Face-to-face interviews are required to ensure that the documentation is reflective of the actual organizational process implementation, and to preclude rating judgments being made solely on the basis of artifacts. The SCAMPI method establishes minimum requirements, described in “Data Collection, Rating, and Reporting” on page I-26, for the extent to which objective evidence from face-to-face interviews must be collected for model practices to corroborate other sources of objective evidence prior to rating goals.

Verification vs. Discovery

If an organization has in place assets, mechanisms, and objective evidence that substantiate its implementation of model practices, it is in the organization’s best interest to share that knowledge to ensure that the appraisal team obtains a complete and accurate understanding of the organization’s implementation of model practices. Many organizations capture this understanding through assets such as traceability and mapping tables from the model to their organizational processes and project instantiations. Implementation of the model within the organization may be further reinforced through additional mechanisms, such as:

- documentation (e.g., policies, process descriptions, project plans)
- verification and oversight activities (e.g., internal appraisals, audits, reviews, status reports)
- tools and resources (e.g., databases, measurement repositories, configuration management tools)

If assets such as these, or indicators of the existence of the assets, are made available to the appraisal team, this leaves the appraisal team the task of verifying whether the objective evidence provided is adequate for substantiation of practice implementation. This verification-based approach is in contrast to the more difficult, error prone, and time-consuming task of investigating each practice to discover the objective evidence needed to substantiate implementation. In a verification-based approach, both the organizational unit and the appraisal team have a clearer picture of what artifacts are available and what might still be needed, thereby minimizing the amount of further investigation necessary in the form of interviews and additional documentation requests. The verification-based approach thus facilitates appraisals that are accurate, repeatable, efficient, and that provide meaningful results; in other words, appraisals that satisfy the essential method characteristics described in “Method Objectives and Characteristics” on page I-15.

Whereas some legacy appraisal methods encouraged organizations to provide such assets, the emphasis is strengthened further in the SCAMPI method, which is designed on the assumption that relevant objective evidence is available for review in advance of the on-site period. This assumption is typically discussed with the appraisal sponsor and his/her representatives during development of the appraisal plan. A key milestone in the appraisal process is a review prior to the appraisal on-site period to determine readiness to proceed with a verification-

based appraisal as planned. If the appraised organization has not provided objective evidence of sufficient quality and completeness to enable a verification-based appraisal, the appraisal plan may need to be renegotiated to reflect the additional effort that must be undertaken for the appraisal team to search for and discover that objective evidence during the on-site period.

Objective Evidence Sources

The SCAMPI method provides for the collection of data from the following sources:

- *Instruments* – Written information relative to the organizational unit’s implementation of CMMI model practices. This can include assets such as questionnaires, surveys, or an organizational mapping of CMMI model practices to its corresponding processes. See “Instruments and Tools” on page I-29 for additional information on the use of appraisal instruments.
- *Presentations* – Information prepared by the organization and delivered visually or verbally to the appraisal team to describe organizational processes and implementation of CMMI model practices. This typically includes such mechanisms as orientation or overview briefings, and demonstrations of tools or capabilities.
- *Documents* – Artifacts reflecting the implementation of one or more model practices. These typically include organizational policies, procedures, and implementation-level artifacts. Documents may be available in hardcopy or softcopy, or may be accessible via hyperlinks in a web-based environment.
- *Interviews* – Face-to-face interaction with those implementing or using the processes within the organizational unit. Interviews are typically held with various groups or individuals, such as project leaders, managers, and practitioners. A combination of formal and informal interviews may be held, using interview scripts or exploratory questions developed to elicit the information needed.

Using multiple data-gathering mechanisms improves the depth of understanding and enables corroboration of the data.

Focused Investigation

Due to the quantity of CMMI model practices that must be investigated and the SCAMPI rules for collection of objective evidence to ensure sufficient coverage of these practices for rating (see “Data Collection, Rating, and Reporting” on page I-26), it is crucial that appraisal teams apply efficient techniques for the collection and management of appraisal data. This focus on efficient data management practices is integral to SCAMPI method concepts, and is emphasized throughout the appraisal process. The term “focused investigation” is used in SCAMPI to describe this concept of optimized investment of appraisal resources. Essentially, this can be described at a top level using the following data collection and investigation paradigms:

- Understand what objective evidence is available, and how it contributes toward implementation of model practices within the appraisal scope.
- Continually consolidate data to determine progress toward sufficient coverage of model practices.
- Focus appraisal resources by targeting those areas for which further investigation is needed to collect additional data or verify the set of objective evidence.
- Avoid unnecessary or duplicated effort that does not contribute additional information toward achievement of sufficient coverage or toward obtaining significantly greater confidence in the appraisal results. For example, keep interviews efficient by asking further questions only about practices for which sufficient data has not already been obtained.

These concepts, derived from the best practices of experienced lead appraisers, are primary mechanisms used to achieve efficient appraisal performance by emphasizing the placement of appraisal team effort where it is most needed. This begins with the initial collection and analysis of objective evidence from the organizational unit. This analysis can be used to determine the adequacy and completeness of the provided objective evidence, and to identify the extent to which further investigation is necessary. The appraisal team's inventory of objective evidence can be annotated to identify practices that are strongly supported, or those that need further clarification. This knowledge can be used as the basis for determining findings that affect appraisal outcomes.

As the appraisal process progresses, the appraisal team aggregates and synthesizes additional objective evidence from process instantiations, and uses this to draw inferences about the overall implementation within the organizational unit. Wherever there are shortcomings in the appraisal team's understanding of the organizational unit's implementation of model practices, data collection strategies can be determined to probe for and obtain additional information. For example, cases where the objective evidence is missing, unclear, or insufficient might be addressed through additional documentation requests or by generating focused questions for specific interview participants. By maintaining a current inventory of the status of the appraisal objective evidence and prioritizing areas where additional information is still needed, these focused investigation approaches can be continuously and iteratively applied to narrow remaining gaps and converge on sufficient coverage for proceeding with rating.

Additional information on focused investigation and continuous consolidation concepts can be found in Appendix C.

Practice Implementation Indicators

The fundamental idea of Practice Implementation Indicators (PIIs) is that the conduct of an activity or the implementation of a practice results in “footprints”—evidence that provides a basis for verification of the activity or practice.

In SCAMPI, Practice Implementation Indicators are the necessary consequence of implementing CMMI model practices. For example, the establishment of an artifact, such as a document, is often an expected outcome resulting from implementation of a model practice. Other indicators may indirectly substantiate implementation of the practice, such as evidence of a status meeting or peer review being held. Members of the organizational unit may affirm through questionnaires or interviews that the practice is implemented. These are all potential “footprints” that can be used as objective evidence to verify and substantiate implementation of model practices.

SCAMPI characterizes PIIs according to the indicator types described in Table I-9.

Table I-9: Practice Implementation Indicator Types

Indicator Type	Description	Examples
Direct artifacts	The tangible outputs resulting directly from implementation of a specific or generic practice. An integral part of verifying practice implementation. May be explicitly stated or implied by the practice statement or associated informative material.	Typical work products listed in CMMI model practices Target products of an “Establish and Maintain” specific practice Documents, deliverable products, training materials, etc.
Indirect artifacts	Artifacts that are a consequence of performing a specific or generic practice or that substantiate its implementation, but which are not the purpose for which the practice is performed. This indicator type is especially useful when there may be doubts about whether the intent of the practice has been met (e.g., an artifact exists but there is no indication of where it came from, who worked to develop it, or how it is used).	Typical work products listed in CMMI model practices Meeting minutes, review results, status reports Performance measures
Affirmations	Oral or written statements confirming or supporting implementation of a specific or generic practice. These are usually provided by the implementers of the practice and/or internal or external customers, but may also include other stakeholders (e.g., managers, suppliers).	Questionnaire responses Interviews Presentations

Appraisal teams are obligated to seek objective evidence of each of these types as a prerequisite to formulating characterizations of practice implementation. The indicator types that will be most appropriate to reflect practice implementation will vary according to the context in which the process is implemented, as well as the practice itself. The appraisal team should

consider all aspects of the process context, such as project size and duration, organizational culture, application domain, customer market, and so on, in determining the appropriateness and sufficiency of indicators. For example, the level of detail necessary for a work breakdown structure will differ widely for a 1-person, 2-week maintenance effort as opposed to a 100-person, multi-year, mission-critical, new product development.

An example of how PII for each of these types might be used in verifying implementation of a model practice is depicted in Figure I-1.

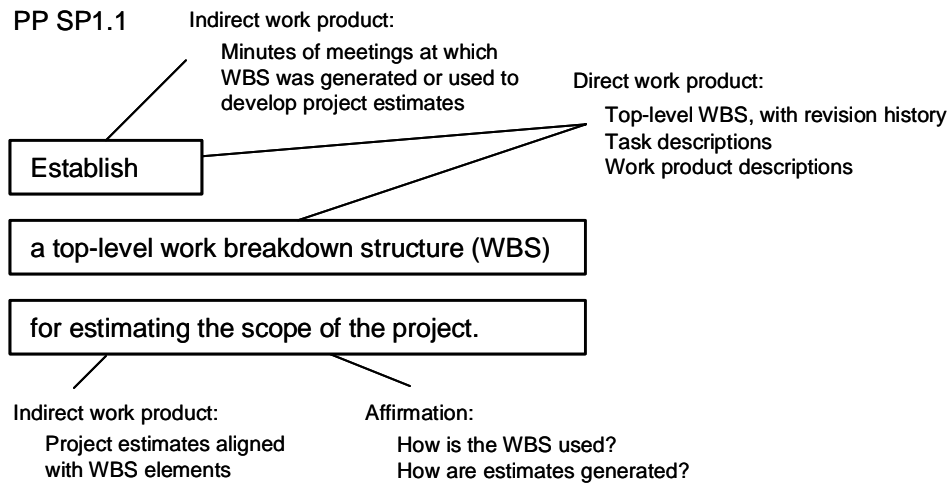

Figure I-1: Example of PII Use

Appraisal teams collect and organize data according to these indicator types. The SCAMPI method defines rules and guidelines (described in “Data Collection, Rating, and Reporting” below) about the amount of data that must be collected for each of these indicator types. A combination of objective evidence according to these indicator types is necessary to corroborate multiple sources of data that may be available for each practice, and to obtain confidence in the accuracy of the data collected. For reasons that are evident, an over-reliance on one type of objective evidence or another is undesirable. Too much dependence on artifacts could result in the perception that the appraisal was a “paper review” and not truly indicative of organizational and/or project behavior. An over-reliance on affirmations could be criticized as not truly objective or repeatable. Therefore, the SCAMPI method requires a balance across these types of objective evidence.

Appendix B contains additional detailed discussion of PII and indicator-based appraisals.

Data Collection, Rating, and Reporting

The appraisal team follows a consensus-based, structured process to synthesize and transform information collected from the sources described in “Objective Evidence Sources” on page I-

23. Data from these sources are collected and considered in several discrete data-gathering sessions, either as integrated appraisal team activities or by subsets of the team organized into mini-teams operating in parallel. Mini-teams are typically organized around related process areas, with mini-team members assigned by the appraisal team leader on the basis of their individual experience, knowledge, and skills.

The SCAMPI data transformation and rating process is depicted in Figure I-2.

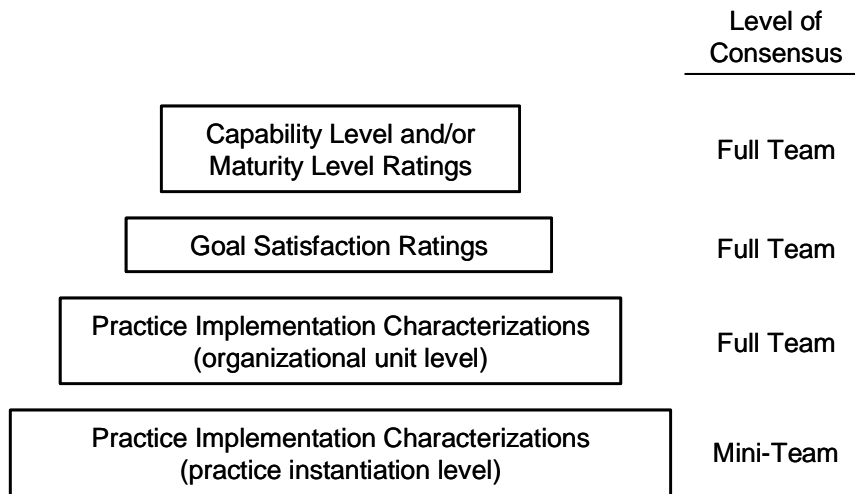

Figure I-2: SCAMPI Rating Process

Team members review objective evidence provided by the organizational unit and identify PIIs relative to the reference model practices. These PIIs are categorized as direct artifacts, indirect artifacts, or affirmations, as described in “Practice Implementation Indicators” on page I-24, and are added to the team’s PII inventory.

Areas of significant strength or weakness observed relative to the implementation of model specific or generic practices are recorded in written observations. Observations are generated primarily for weaknesses, or “gaps,” of the implementation compared to the intent of a model practice. Observations of strengths should be reserved for implemented practices that are particularly effective and are candidates for inclusion in aggregated findings. “Gratuitous” strengths that simply reflect a sufficient implementation of a practice can produce substantial data management overhead that does not contribute toward generation of findings; these are more effectively captured as indicators in the appraisal team’s PII inventory. Observations may also be generated for alternative practices, which are acceptable alternatives to implementing one or more model practices that contribute equivalently to the satisfaction of process area goals.

Characterizing Practices

Verification of Practice Implementation Indicators continues in this way at the instantiation level until sufficient objective evidence has been obtained to characterize the implementation of a specific or generic practice. Sufficiency at the practice level for an instantiation is determined when direct artifacts covering the intent of the practice have been verified for the practice and corroborated by indirect artifacts or affirmations. Consensus is obtained at the mini-team level on the sufficiency of instantiation-level practice implementation indicators and accuracy of observations of strengths and weaknesses.

Based upon the practice implementation data for a process instantiation, the appraisal team (or typically a mini-team) assigns values to characterize the extent to which the CMMI model practice is implemented. Each practice is characterized as Fully Implemented (FI), Largely Implemented (LI), Partially Implemented (PI), or Not Implemented (NI). The intent of this characterization is to effectively summarize the appraisal team's judgment of practice implementation as a mechanism to identify where team judgment is most needed, and to prioritize areas where further investigation or corroboration may be necessary. These characterization values are an aid, not a replacement, for the observations recorded for strengths and weaknesses, which are used as a basis for rating decisions.

Upon assigning characterization values for a given model practice for each instantiation, the characterization values are aggregated, using full appraisal team consensus, to the organizational unit level. Observations reflecting strengths and weaknesses across instantiations are similarly aggregated to the organizational unit level, and form the basis for rating. Where team judgment is necessary to characterize practice implementation, these decisions are made considering factors such as the mix of practice characterizations, the reason for the instantiation-level characterizations, and the severity of the associated weaknesses (in aggregate).

Tracking Progress

The appraisal team uses focused investigation techniques (see "Focused Investigation" on page I-23) to track progress toward sufficient coverage necessary for rating process area goals within the appraisal scope. Revisions to the data collection plan may be necessary to ensure that adequate objective evidence is obtained from each instantiation (e.g., project) for each specific and generic practice within the reference model scope of the appraisal. If insufficient objective evidence is available, the data collection plan may be revised to conduct additional data-gathering sessions. Focused investigation techniques can be used to ensure progress toward sufficient coverage of model practices, goals, and process areas within the appraisal scope.

Generating Findings

Strengths and weaknesses identified across instantiations are synthesized and aggregated to statements of preliminary findings, expressed at the organizational unit level. These are often organized at the level of process area goals using common themes. Preliminary findings are provided to the organizational unit for validation; the mechanisms and timeframe used for this may vary across the appraisal modes of usage (internal process improvement, supplier selection, process monitoring). During this activity, the appraisal team is still in the process of collecting data to ensure that an accurate understanding of the organizational process implementation is obtained. Feedback from the participants in the appraisal is used to validate the preliminary findings, and may result in additional observations or revision to the findings. The appraisal team may also request additional data sources for areas where their understanding of the organization's implementation of model practices is insufficient. Final findings are generated based on the complete, validated set of appraisal data (i.e., findings, aggregated strengths and weaknesses, and inventory of PIIs).

Generating Ratings

Ratings are generated based on the set of validated appraisal data. At a minimum, ratings are generated for each of the process area generic and specific goals within the appraisal reference model scope. Ratings may also be generated for process areas, capability levels, or maturity levels if desired by the appraisal sponsor. Maturity level ratings and/or capability level ratings are based on the definitions of capability levels and maturity levels in the CMMI models. Refer to Process Description 2.4, "Generate Appraisal Results," for additional information about SCAMPI rating processes.

Reporting Results

The results of the appraisal are reported to the appraisal sponsor. For source selection and process monitoring contexts, these results are also provided to the appraised organization; the mechanisms and timeframe used for this may be subject to acquisition or contractual restrictions. An appraisal record is generated and provided to the sponsor, documenting further information regarding the appraisal.

A subset of this data is provided to the CMMI Steward for the purposes of quality control and the collection of appraisal measures for reporting to the appraisal community. The appraisal data to be provided is defined by the Steward separately from this document to allow for continuous improvement of appraisal reporting apart from the CMMI Product Suite.

Instruments and Tools

Instruments are artifacts used in an appraisal for the collection and presentation of data. Instruments are provided by the organizational unit to inform the appraisal team about the processes implemented in the organization and how they relate to the CMMI reference mod-

els. Instruments can take various forms, including questionnaires, surveys, site orientation packets, and mappings from CMMI practices to the organizational or project processes.

The SCAMPI method does not require any particular instrument or presentation format, only that an instrument be used. Instruments can be used most effectively if they provide the appraisal team with an in-depth understanding of the organizational implementation of the model, on a practice-level basis for each instantiation to be investigated in the appraisal. Instruments also often provide an opportunity for the organizational unit to provide a self-characterization of their implemented processes, identify applicable substantiating objective evidence, and specify any additional comments that might be useful in understanding the implemented processes. Used in this manner, instruments can support the SCAMPI method emphasis on verification-based appraisals and minimize the need for on-site discovery of objective evidence (see “Verification vs. Discovery” on page I-22), thus helping to facilitate efficient appraisal performance.

As described in “Practice Implementation Indicators” on page I-24, the SCAMPI method emphasizes the use of PIIs. Organizations may provide as input to the appraisal a PII database (PIIDB), with a mapping of model practices to corresponding processes and objective evidence that can be used to verify practice implementation. It is anticipated that many organizations will have existing assets in place that reflect their process implementation and mapping to CMMI model practices. These instruments can be used as a source of appraisal data in much the same way as a PIIDB. The collection of these model mappings and indicators can be a valuable resource for process improvement at the organization and project levels, and a rich source of data for process appraisals using a variety of Class A, B, and C appraisal methods.

It is recommended that a member of the appraisal team facilitate the entry of data into instruments where feasible, to ensure that appropriate data are obtained. This can help the appraised organization clarify or interpret the intent of the model practices, understand what data are expected, and focus the responses. The entry of either too much or too little data into instruments can be problematic for both the appraisal team and the appraised organization and result in inefficient use of resources.

Effective management of appraisal data is a significant challenge that can be simplified with the use of automated tools. The CMMI Steward provides a rudimentary toolkit to Lead Appraisers that can be used to collect practice-level questionnaire data; characterize, consolidate, and summarize responses; and record observations based on these responses where appropriate. Several vendor tools are also available in the marketplace. The choice of tools is largely one of personal preference; some experienced appraisers prefer manual techniques, such as wall charts, to record observations and findings.

Effective Team Practices

Appraisal team dynamics and effective group techniques contribute significantly to the ability to conduct SCAMPI appraisals. The appraisal team leader can help focus team activities so that effort is spent wisely toward achievement of method requirements and appraisal objectives. “Method Performance” on page I-18 contains several efficiency ideas identified by the appraisal community as potential areas for improvement. SCAMPI features encourage effective team practices that, with the support of the appraisal team leader, can address some of these issues. This includes areas such as:

- *Verification-based approach* – Verification of PIIs provided as objective evidence by the organization in advance of the appraisal is emphasized to reduce the extent of data that must be obtained through discovery techniques during the on-site period. Even in this case, it is recommended that the entry of PII data by the organizational unit be facilitated to ensure that an appropriate and useful set of objective evidence is available; too much data that is not useful is just as great a problem as too little data. (See “Verification vs. Discovery” on page I-22.)
- *Reduced crafting of observations* – In an indicator-based appraisal, greater emphasis is placed on verification of PIIs, and there is less need overall for crafting notes and observations. Observations need not be generated simply to acknowledge satisfactory implementations or existence of artifacts, but can focus more on identifying weaknesses or significant strengths that can be expected to be included in the findings.
- *Consensus* – Mini-teams are given the authority to reach consensus on practice implementation at the instantiation level; full team consensus is required for aggregation to the organizational unit level. (See Figure 2.2.6-1.) The characterization of practice implementation (FI, LI, PI, NI; see “Data Collection, Rating, and Reporting” on page I-26) can also help facilitate consensus on whether implementations satisfy model intent, either at the instantiation or organizational unit level. The consensus, discussion, and decision-making processes used by the appraisal team can be significant sources of inefficiency if not monitored closely.
- *Corroboration* – Corroboration is built into the method through requirements for multiple types of objective evidence (direct artifacts, indirect artifacts, affirmations). (See Section 2.2.5.)
- *Effective data management* – The SCAMPI method provides ways to collect, organize, and manage appraisal data efficiently, and to facilitate the team decisions that must be made based on the set of objective evidence. The focused investigation techniques described in Section 2.2.4 can help keep the team oriented on what objective evidence has been collected, what remains to be collected, and how it will be collected. This can be greatly enhanced through the use of automated support tools. A thorough understanding of progress toward sufficiency of coverage can help focus data collection. Interviews, in particular, can be shortened by focusing on specific data collection needs.

Several additional effective team practices are targeted toward specific subsets of the appraisal, and are included as suggested implementation or tailoring options within individual process descriptions in Part II.

Method Description

This section provides an overview of the SCAMPI method architecture, including appraisal phases, processes, and activities. These descriptions are high-level abstractions of the process descriptions contained in Part II of this document.

A summary of the SCAMPI method processes and activities for each of the three appraisal phases is contained in Tables I-10 through I-12.

The interactions between the processes are depicted in the process flow diagrams in Figures I-3 through I-5. These diagrams show the work products that are inputs and outputs at the process level for accomplishing the purpose of the appraisal. Additional analysis was done to ensure that the activities within each process use and provide the inputs and outputs of the process. However, that detailed analysis is not presented here.

The process flows generally show summarized and completed products. For instance, the appraisal input generated by Analyze Requirements initially is provided to the Develop Appraisal Plan process with some elements missing that are generated in other processes. These flow back to Analyze Requirements in the appraisal plan. The final appraisal input as coordinated with the sponsor is then produced as a completed product. Additional administrative and support products, such as appraisal checklists, will be produced but are not included in these diagrams.

The time sequences of appraisals are also shown in the process flow diagrams. Figures I-6 and I-7 show nominal schedules for conduct of appraisals in both assessment and evaluation modes. There are several differences between and tailoring options within each of these schedules. They are examples and are not intended to be requirements.

For assessments, the preparation of participants (“Prep” in the diagram) can be at any time between the identification of the participants and the administration of the instruments. If a set of PIIs assembled by the organization for previous appraisals is chosen as the instrument, this would be at the beginning of data collection. If an additional completion of instruments beyond those provided in the initial objective evidence is not required, this preparation could be delayed to just prior to interviews. Other options include but are not limited to the timing of team selection, number and timing of readiness reviews, and sequence of artifact and interview activities.

For evaluations, there are several differences in sequence from assessments. For instance, the analysis of initial objective evidence occurs after the organizations have responded to the request for data, which in turn follows the completion of the Data Collection Plan. Another difference is the delay of the delivery of the appraisal results until after all organizations have

been appraised. An example of timing options is that the identification of the appraisal team leader may be delayed until near the end of the planning activities. This ordering of events must be accommodated by the plan; for example, completion of the Analyze Requirements and Develop Appraisal Plan processes must be rescheduled to allow the appraisal team leader to approve the appraisal input and the appraisal plan.

Table I-10: SCAMPI Phase Summary: Plan and Prepare for Appraisal

Phase	Process	Purpose	Activities
1 Plan and Prepare for Appraisal	1.1 Analyze Requirements	Understand the business needs of the organizational unit for which the appraisal is being requested. The appraisal team leader will collect information and help the appraisal sponsor match appraisal objectives with their business objectives.	1.1.1 Determine Appraisal Objectives 1.1.2 Determine Appraisal Constraints 1.1.3 Determine Appraisal Scope 1.1.4 Determine Outputs 1.1.5 Obtain Commitment to Appraisal Input
	1.2 Develop Appraisal Plan	Document requirements, agreements, estimates, risks, method tailoring, and practice considerations (e.g., schedules, logistics, and contextual information about the organization) associated with the appraisal. Obtain, record, and make visible the sponsor's approval of the appraisal plan.	1.2.1 Tailor Method 1.2.2 Identify Needed Resources 1.2.3 Determine Cost and Schedule 1.2.4 Plan and Manage Logistics 1.2.5 Document and Manage Risks 1.2.6 Obtain Commitment to Appraisal Plan
	1.3 Select and Prepare Team	Ensure that an experienced, trained, appropriately qualified team is available and prepared to execute the appraisal process.	1.3.1 Identify Team Leader 1.3.2 Select Team Members 1.3.3 Prepare Team
	1.4 Obtain and Analyze Initial Objective Evidence	Obtain information that facilitates site-specific preparation. Obtain data on model practices used. Identify potential issue areas, gaps, or risks to aid in refining the plan. Get preliminary understanding of the organizational unit's operations and processes.	1.4.1 Prepare Participants 1.4.2 Administer Instruments 1.4.3 Obtain Initial Objective Evidence 1.4.4 Inventory Objective Evidence
	1.5 Prepare for Collection of Objective Evidence	Plan and document specific data collection strategies including sources of data, tools and technologies to be used, and contingencies to manage risk of insufficient data.	1.5.1 Perform Readiness Review 1.5.2 Prepare Data Collection Plan 1.5.3 Replan Data Collection (if needed)

Table I-11: SCAMPI Phase Summary: Conduct Appraisal

Phase	Process	Purpose	Activities
2 Conduct Appraisal	2.1 Examine Objective Evidence	Collect information about the practices implemented in the organizational unit and relate the resultant data to the reference model. Perform the activity in accordance with the data collection plan. Take corrective actions and revise the data collection plan as needed.	2.1.1 Examine Objective Evidence from Instruments 2.1.2 Examine Objective Evidence from Presentations 2.1.3 Examine Objective Evidence from Documents 2.1.4 Examine Objective Evidence from Interviews
	2.2 Verify and Validate Objective Evidence	Verify the implementation of the organizational unit's practices for each instantiation. Validate the preliminary findings, describing gaps in the implementation of model practices. Each implementation of each practice is verified so it may be compared to CMMI practices, and the team characterizes the extent to which the practices in the model are implemented. Gaps in practice implementation are captured and validated with members of the organizational unit. Exemplary implementations of model practices may be highlighted as strengths to be included in appraisal outputs.	2.2.1 Verify Objective Evidence 2.2.2 Characterize Implementation of Model Practices 2.2.3 Validate Practice Implementation Gaps
	2.3 Document Objective Evidence	Create lasting records of the information gathered by identifying and then consolidating notes, transforming the data into records that document practice implementation, as well as strengths and weaknesses.	2.3.1 Take/Review/Tag Notes 2.3.2 Record Presence/Absence of Objective Evidence 2.3.3 Document Practice Implementation Gaps 2.3.4 Review and Update the Data Collection Plan
	2.4 Generate Appraisal Results	Rate goal satisfaction based upon the extent of practice implementation throughout the organizational unit. The extent of practice implementation is determined/judged based on validated data (e.g., the three types of objective evidence) collected from the entire representative sample of the organizational unit. The rating of capability levels and/or maturity levels is driven algorithmically by the goal satisfaction ratings.	2.4.1 Derive Findings and Rate Goals 2.4.2a Determine Process Area Capability Level 2.4.2b Determine Satisfaction of Process Areas 2.4.3a Determine Capability Profile 2.4.3b Determine Maturity Level 2.4.4 Document Appraisal Results

Table I-12: SCAMPI Phase Summary: Report Results

Phase	Process	Purpose	Activities
3 Report Results	3.1 Deliver Appraisal Results	Provide credible appraisal results that can be used to guide actions. Represent the strengths and weaknesses of the processes in use at the time. Provide ratings (if planned for) that accurately reflect the capability level/maturity level of the processes in use.	3.1.1 Present Final Findings 3.1.2 Conduct Executive Session(s) 3.1.3 Plan for Next Steps
	3.2 Package and Archive Appraisal Assets	Preserve important data and records from the appraisal, and dispose of sensitive materials in an appropriate manner.	3.2.1 Collect Lessons Learned 3.2.2 Generate Appraisal Record 3.2.3 Provide Appraisal Feedback to CMMI Steward 3.2.4 Archive and/or Dispose of Key Artifacts

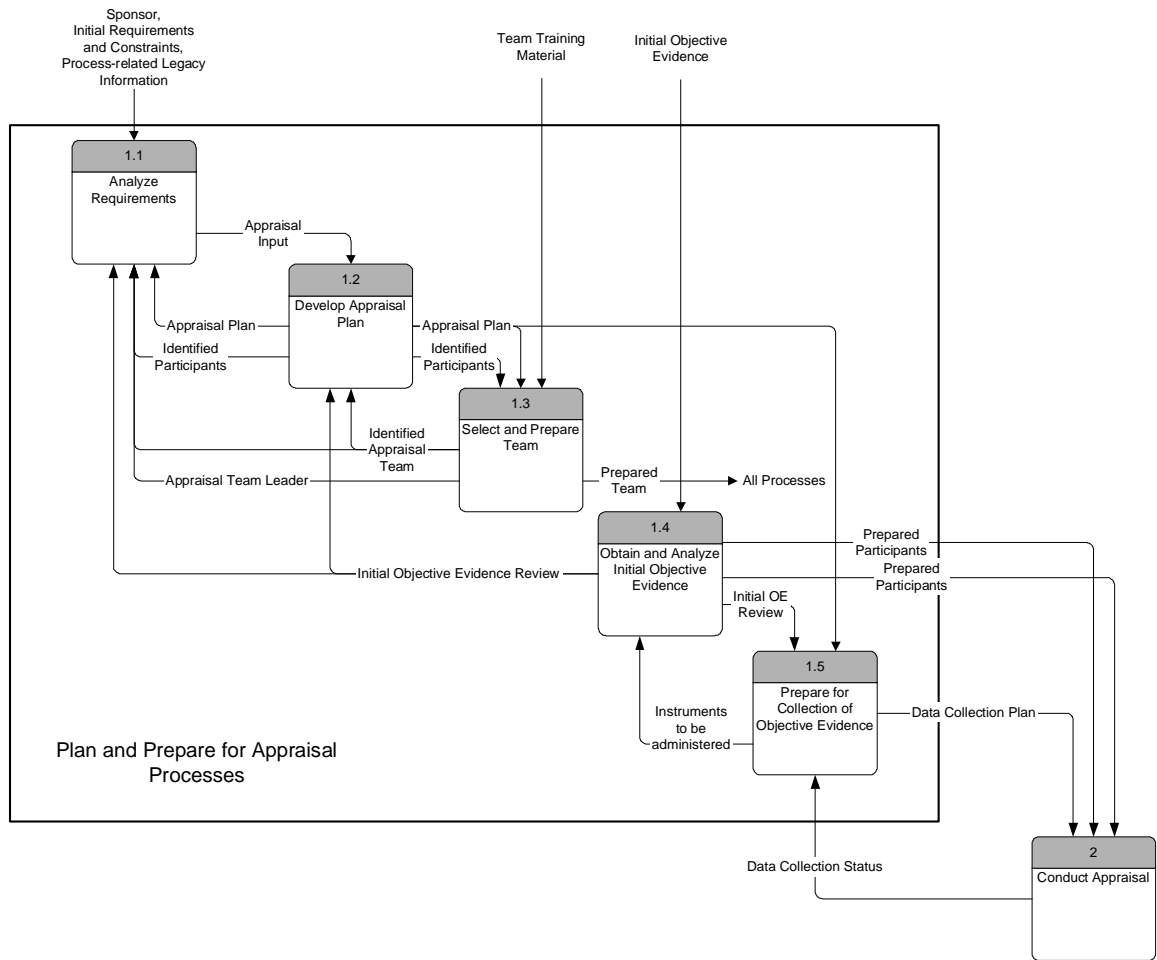

Figure I-3: Process Flows, Plan and Prepare Processes

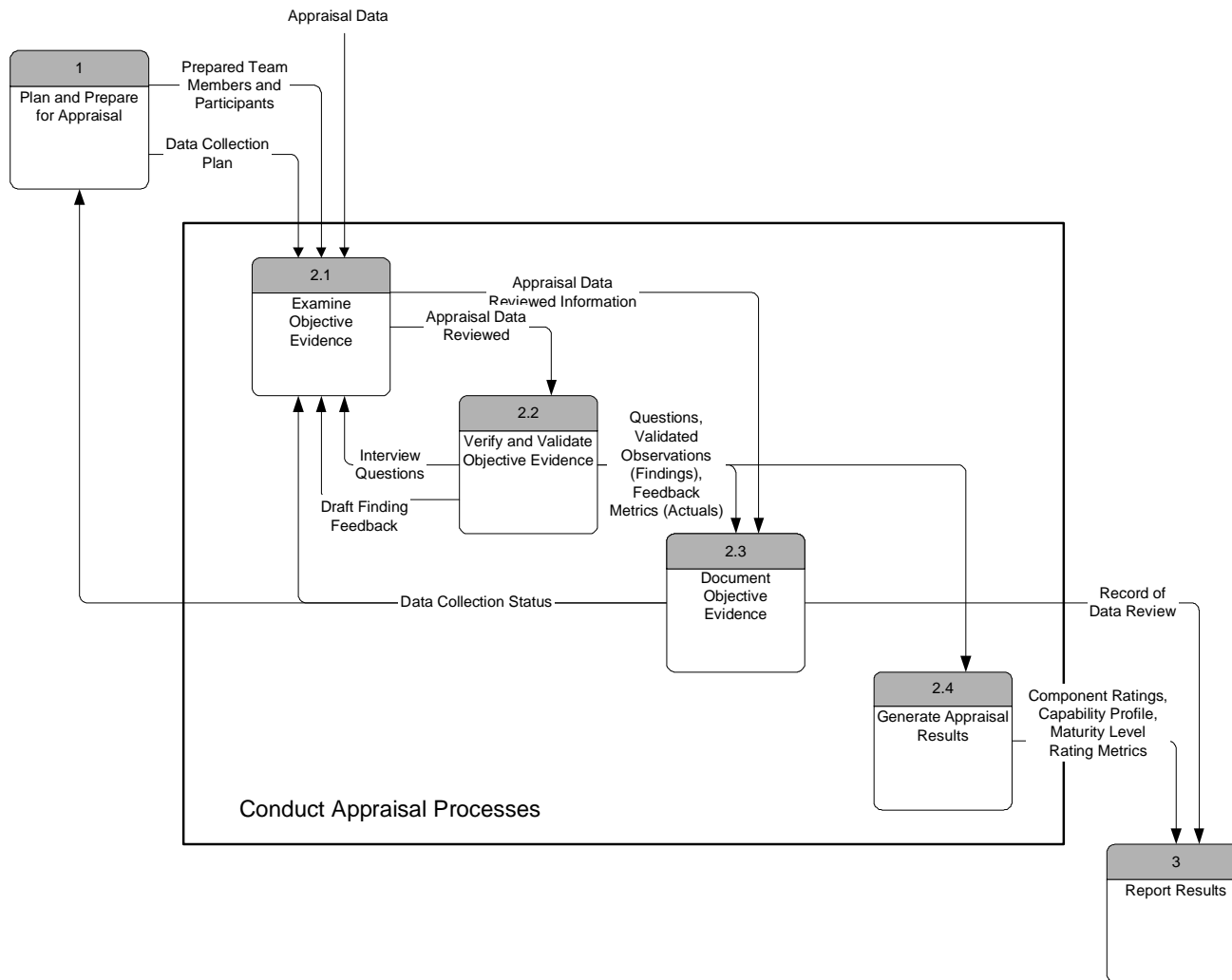

Figure I-4: Process Flows, Conduct Appraisal Processes

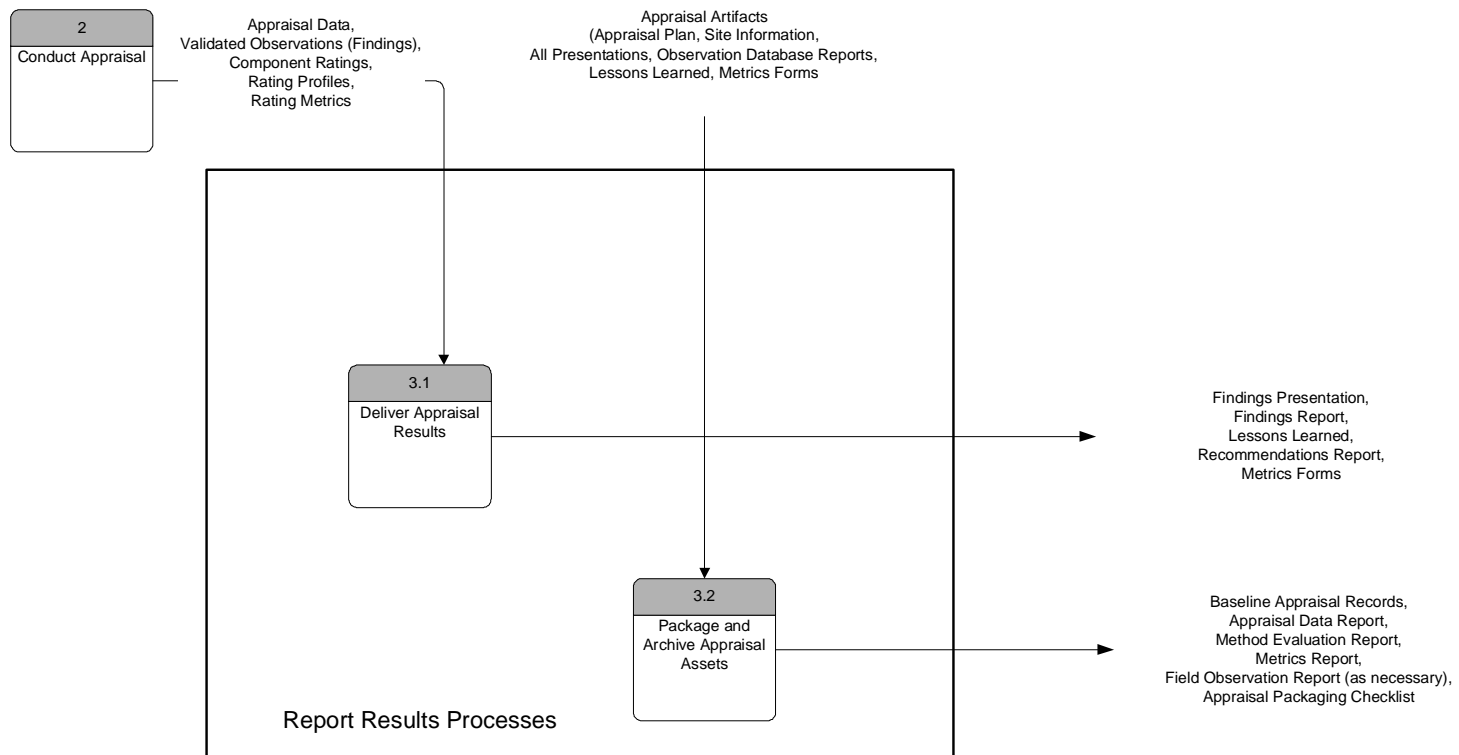

Figure I-5: Process Flows, Report Results Processes

Nominal Assessment Schedule View

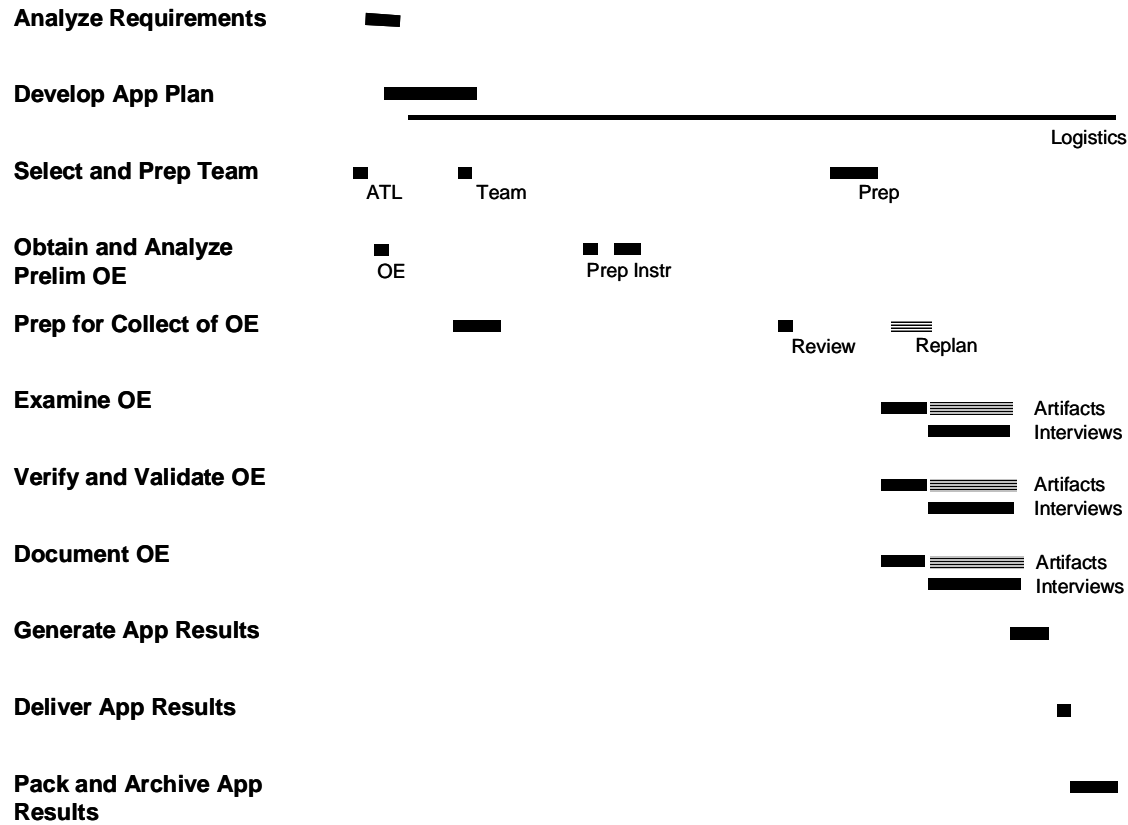

Figure I-6: Nominal Schedule for Assessment Mode

Nominal Evaluation Schedule View

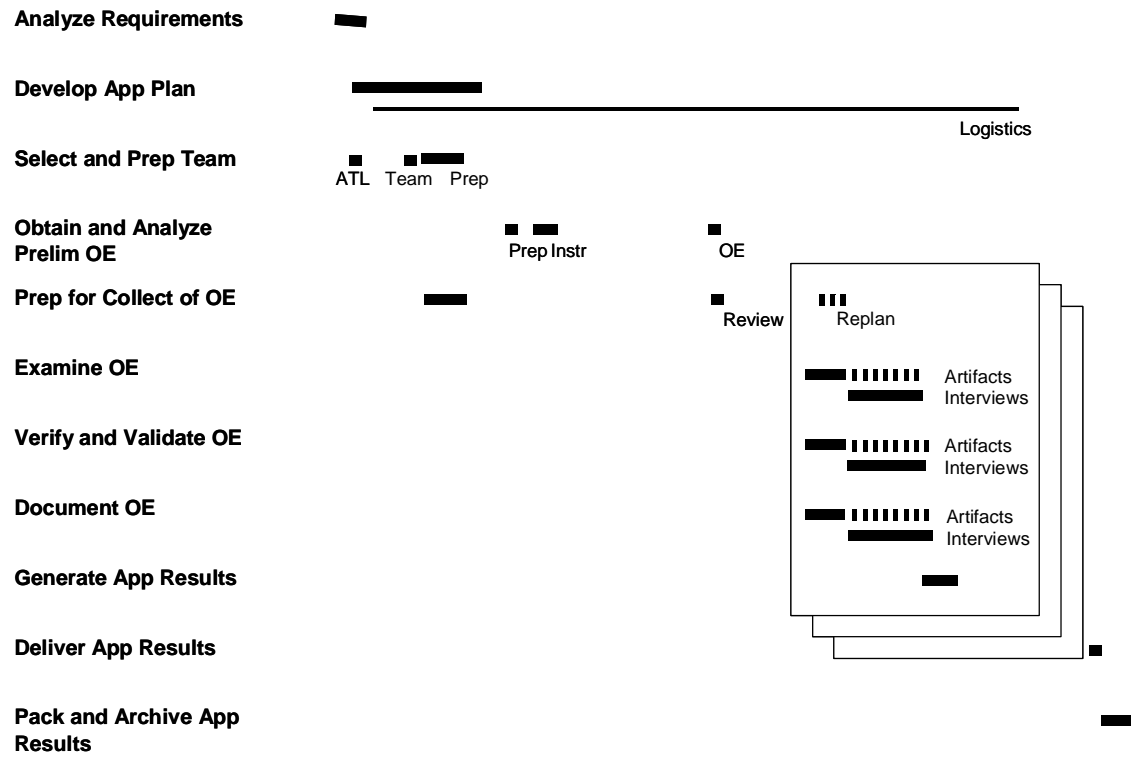

Figure I-7: Nominal Schedule for Evaluation Mode

Part II: Process Definitions

1.1 Analyze Requirements

Purpose	Understand the business needs of the organization for which the appraisal is being requested. The appraisal team leader will collect information and help the appraisal sponsor match appraisal objectives with their business objectives.
Entry Criteria	<ul style="list-style-type: none">• An appraisal sponsor has decided that a SCAMPI appraisal should be performed.• People who can provide statements of requirements for the appraisal are available.
Inputs	<ul style="list-style-type: none">• Sponsor• Initial requirements and constraints• Process-related legacy information
Activities	1.1.1 Determine Appraisal Objectives 1.1.2 Determine Appraisal Constraints 1.1.3 Determine Appraisal Scope 1.1.4 Determine Outputs 1.1.5 Obtain Commitment to Appraisal Input
Outputs	The appraisal input
Outcome	The decision to proceed with the appraisal based on a shared understanding of the appraisal objectives, constraints, outputs, and scope.
Exit Criteria	<ul style="list-style-type: none">• Initial contact between the appraisal sponsor and authorized SCAMPI Lead Appraiser has occurred.• The Lead Appraiser has been given access to members of the sponsoring organization.• The appraisal input has been approved by the appraisal sponsor and placed under change management.

Continued on next page

1.1 Analyze Requirements (continued)

Key Points	At this early stage in the process, gathering information that supports good planning is most important. Often, the appraisal team leader must educate members of the sponsor's organization in the purpose and role of appraisals.
Tools and Techniques	<p>Collaborative consultation between the appraisal team leader and the appraisal sponsor is important in this activity. The appraisal team leader may be able to simply interview the sponsor to get the needed information and reach agreements. In some settings, a series of meetings with different stakeholders may be needed to elicit and build consensus on the business needs that can be met through a SCAMPI appraisal.</p> <p>Understanding the history of appraisals in the organization, especially the organizational and model scope of past appraisals, is important for understanding the requirements for the appraisal under consideration. The choices sponsors make about appraisal scope are often tied to their (sometimes-unstated) priorities for process improvement.</p>
Metrics	<p>A number of metrics support the appraisal team leader's monitoring of this work:</p> <ul style="list-style-type: none">• calendar time between initial contact and finalization of requirements• effort expended to gather and analyze requirements• number of meetings with representatives of the sponsoring and/or appraised organization
Verification and Validation	<p>The exit criterion for this activity is the formal approval of the appraisal input and its placement under change management.</p> <p>Review of the documented agreements resulting from the work of this set of activities will serve to validate the requirements, which feed into appraisal planning.</p>
Records	The appraisal input
Tailoring	<p>The experience of the sponsor with process appraisals will drive tailoring choices for this process.</p> <ul style="list-style-type: none">• A relatively inexperienced appraisal sponsor will need a great deal of information and collaborative consultation to provide meaningful and complete requirements for the appraisal.• Experienced sponsors may have overly aggressive requirements.

Continued on next page

1.1 Analyze Requirements (continued)

Interfaces with Other Processes

This process is a foundation for the success or failure of the entire appraisal; it is at this point in the appraisal that the most leverage exists for avoiding problems and issues downstream. Gathering and understanding the requirements for the conduct of a SCAMPI appraisal is vital to making appropriate decisions and providing value to the sponsor. Many examples of problems encountered during appraisals can be traced to shortcomings in the conduct of this process. The extent to which the activities described here are distinct from the activities described in the next process, Develop Appraisal Plan, will depend on the strategy and preferences of both the appraisal team leader and the appraisal sponsor.

Summary of Activities

The objectives that motivate the conduct of an appraisal must be well understood so that appropriate participants, tailoring decisions, and appraisal outputs can be selected. The constraints that shape the appraisal enactment, in light of the objectives, may limit achievement of the desired result if they are not adequately understood and negotiated. A clear agreement regarding appraisal outputs and their intended usage will help maintain the sponsorship needed for conducting the appraisal and acting on the results. Establishing agreement on these objectives, constraints, outputs, and intended usage forms the basis for a commitment to the plan for conducting the appraisal.



1.1.1 Determine Appraisal Objectives

Activity Description	<p>The business needs for process improvement drive the requirements for the conduct of any given appraisal, and generally include one or more of three closely related factors:</p> <ul style="list-style-type: none">• reducing costs• improving quality• decreasing time to market <p>The fundamental premise of process improvement is that organizational processes significantly impact these factors.</p> <p>A fair and objective characterization of the processes in use in the organization(s) is the essential reason for conducting an appraisal. In addition to this motivation, a sponsor's desire to conduct an appraisal could be driven by one or more of the following business-related objectives:</p> <ul style="list-style-type: none">• Document a credible benchmark that reflects successful process improvement.• Evaluate areas of potential risk that may affect the performance of the organization.• Involve members of the appraised organization in improving the performance of the process.• Support specific decisions related to the direction of a new or existing improvement program.• Motivate a supplier to focus on process issues that affect contract performance.
Required Practices	<ul style="list-style-type: none">• Identify sponsor and relevant stakeholders, and establish communication.• Document business and appraisal objectives.• Ensure the alignment of appraisal objectives to business objectives.• Determine and document the appraisal usage mode (Internal Process Improvement, Supplier Selection, Process Monitoring).
Parameters and Limits	<p>At least one communication between the appraisal team leader and sponsor is required. (Some usage modes may limit this significantly; others may require more than one interaction.)</p>

Continued on next page

1.1.1 Determine Appraisal Objectives (continued)

Optional Practices

None.

Implementation Guidance

Organizations with experience in the use of appraisals may have a clear set of appraisal objectives identified in advance of contacting a Lead Appraiser. This provides the Lead Appraiser with a starting point, but does not permit him or her to “skip” this activity.

In some cases the usage mode will be self-evident; however, there may be instances where the appraisal sponsor either may not be sure or may have made an assumption that is not founded on fact. The appraisal team leader is responsible for ensuring that the best choice of usage mode is made consistent with the sponsor’s input and direction.

Also note that the roles of appraisal sponsor and senior site manager may be played by the same person or by two individuals, depending on the usage mode.

Depending on the structure of the appraised organization, as well as the usage mode, it is often important to distinguish the role of senior site manager from that of appraisal sponsor. For some appraisals, these two roles are encompassed in the duties of a single person. For other appraisals, these two roles may represent two people working many time zones away from each other.



1.1.2 Determine Appraisal Constraints

Activity Description The constraints within which the appraisal must be conducted are determined based on a dialog between the appraisal team leader and the appraisal sponsor and/or senior site manager. This typically is an iterative process in which the preferences of the appraisal sponsor, the limits of the method, and the consequent resource requirements are balanced against each other to arrive at an optimal set of appraisal input parameters.

- Required Practices**
- Establish high-level cost and schedule constraints.
 - Determine which process areas (PAs) and organizational entities are to be included.
 - Determine minimum, maximum, or specific sample size or coverage that is desired for the appraisal.
 - Negotiate constraints and objectives with stakeholders to ensure feasibility.
 - Document negotiated constraints to be met.
-

Parameters and Limits At least one communication between the appraisal team leader and sponsor is required. (Some usage modes may limit this significantly; others may require more than one interaction.)

Constraints on cost and schedule identified during this early stage of the appraisal are expected to be high-level, and not detailed estimates. They may take the form of statements such as “We need this done in Q4,” “You can’t use more than five of my people on the team,” and “I can’t afford to have it last more than a month.” Constraints identified by the appraisal input must be negotiated between the sponsor and the appraisal team leader.

Continued on next page

1.1.2 Determine Appraisal Constraints (continued)

Optional Practices Document the rationale for choices made and the associated tradeoffs as a resource for later planning and future appraisals.

Implementation Guidance Practical limitations relating to time, cost, and effort are clarified and negotiated in the context of other requirements the sponsor has. The business context in which the appraisal is conducted drives choices that the appraisal team leader needs to make. Appraisals should not be conducted in isolation from other activities relating to process management and improvement. The needs of related stakeholders, be they acquisition organizations or division heads managing the Engineering Process Group, often place requirements on the conduct of the appraisal.



1.1.3 Determine Appraisal Scope

**Activity
Description**

The appraisal scope consists of the reference model scope and the organizational scope to be examined during the appraisal. The model scope must be determined and documented early in the planning process, using the staged representation or the continuous representation. The appraisal team leader is responsible for ensuring that the sponsor makes an informed choice regarding the PAs included in the scope of the appraisal and the model representation. The selection of appraisal outputs should be driven by the understanding of their intended use, established during the requirements analysis activity, and may dictate some selections in model scope. The organizational scope defines the bounds of the organization to be investigated during the appraisal. Instantiations (i.e., for practices implemented by projects, each project; for practices implemented organization-wide, the instance) are selected as representative of the organization and the contexts in which processes are implemented.

Reconciling the interactions between model scope and organization scope is an important part of this activity. A particular organization scope begets a particular model scope; a particular model scope requires a particular organization scope.

**Required
Practices**

- Determine and document the reference model scope and representation to be used for the appraisal.
 - Determine and document the organizational unit to be investigated during the appraisal.
-

Continued on next page

1.1.3 Determine Appraisal Scope (continued)

Parameters and Limits

The reference model scope includes the PAs and associated maximum capability level and/or maturity level that will be investigated by the appraisal team (i.e., the generic goals that will be rated for each PA within the scope of the appraisal). Note that the selection of the reference model representation should have been discussed during the setting of appraisal objectives, because the representation selected may impact the achievability of these objectives.

The model scope of the appraisal must encompass at least one PA. All generic goals and specific goals up to and including the target capability level and/or maturity level for each selected PA must be rated; individual goals within a PA cannot be excluded.

Instantiations must be selected that are representative of the implemented processes and functional areas being investigated within the organizational unit, and that operate within a coherent process context (see glossary for definition). This is also sometimes known as the organizational scope of the appraisal. The rationale for selecting these elements as representative of the organizational unit should be documented.

Typically, the organizational unit will be specified in such a manner that (a) at least two instances of the processes being investigated are available as sources of objective evidence and (b) a representative coverage of the life cycles in use within the organization is obtained. Selection of instantiations within the organizational unit may be accomplished through a survey form, or through summarizing information learned from discussions with members of the organization. For processes enacted at the organization level (such as Organizational Training), multiple instances are not required.

The representative instantiations to be investigated during the appraisal will also drive the selection of participants needed to provide sources of objective evidence. An initial determination of appraisal participants, by name and role, should be negotiated with the appraisal sponsor and/or the senior site manager as part of the early determination of organizational scope. This will be refined later during detailed appraisal planning.

Optional Practices

Use broad-based survey instruments or a Practice Implementation Indicator (PII) database to characterize the population of projects or divisions in an organization before determining the organizational scope of the appraisal.

Continued on next page

1.1.3 Determine Appraisal Scope (continued)

Implementation Guidance There are two primary parameters of the appraisal enactment that contribute significantly to the resulting cost (in terms of effort): the PA scope of the CMMI model encompassed by the appraisal and the number and size of projects selected. While other parameters contribute to the cost and schedule of an appraisal, these two scope parameters provide the greatest opportunity to shape the magnitude of the appraisal. SCAMPI requires that findings for the organizational unit be derived from objective evidence on the implementation of practices collected from each of the organizational process instantiations included in the appraisal. The size and number of instantiations investigated should be selected to form a valid sample of the organizational unit to which the results will be attributed.

Clearly, a broadly defined organizational unit (e.g., a multi-national enterprise) will require collecting and analyzing significantly more objective evidence than a narrowly defined organizational unit (e.g., a specific product line within a specific business unit at a single geographical location).

The organization to which appraisal results will be attributed should be described accurately in all statements made by the appraisal team leader and sponsor. It is the responsibility of the appraisal team leader to understand the larger organizational context in which the appraised organizational unit resides. Familiarity with the nature of departmental structures, matrixed subject matter expert groups, integrated product teams, program and project groupings, or product line implications that may affect the interpretation of appraisal outcomes will aid in obtaining this understanding.

The appraisal team leader should work with representatives from the organization to document a clear statement of the model and organizational scope of the appraisal. The model scope should be documented using a list of PAs to be included in the appraisal, as well as the model components to be rated by the appraisal team. The organizational scope of the appraisal should be documented in the clearest terms possible, given the nature of the organizational structure in place. It is often difficult to specify unambiguous boundaries without resorting to naming individual people in some organizations. Information about the organizational unit should be documented in a way that allows future appraisal sponsors to replicate (exactly) the scope of the organization appraised. This information should be in the appraisal plan, and used (in summary form if needed) in briefing the appraisal team and appraisal participants.



1.1.4 Determine Outputs

Activity Description	<p>Identify the specific appraisal outputs to be produced. Some appraisal outputs are required and additional outputs are tailorable (see Parameters and Limits and Optional Practices).</p> <p>Obtain unambiguous answers to the following questions:</p> <ul style="list-style-type: none">• What ratings will be generated during the appraisal?• Will a final report be written to document appraisal results?• Will recommendations on how to address specific findings be generated and reported?
Required Practices	<ul style="list-style-type: none">• Review required SCAMPI outputs with the appraisal sponsor. Review and select optional SCAMPI outputs with the appraisal sponsor.• Determine the recipients of appraisal outputs.
Parameters and Limits	<p>Required SCAMPI outputs include</p> <ul style="list-style-type: none">• Appraisal Record (see activity 3.2.2, Generate Appraisal Record)• Appraisal Disclosure Statement (see activity 2.4.4, Document Appraisal Results)• CMMI Steward Data (see activity 3.2.3, Provide Appraisal Feedback to CMMI Steward) <p>As stated in the ARC, at least all the goals for the process area or areas investigated by the team must be rated, although the choice may be made to not disclose the ratings to anyone other than the appraisal sponsor.</p> <p>At a minimum, the sponsor gets the following appraisal outputs:</p> <ul style="list-style-type: none">• final findings, including statements of strengths and weaknesses documented by the team for every PA investigated• all ratings planned for and generated by the team <p>Decisions reached on appraisal outputs, including what ratings will be reported, are documented in the appraisal input.</p>

Continued on next page

1.1.4 Determine Outputs (continued)

Optional Practices

The appraisal sponsor may request that additional rating outputs be generated as a result of the appraisal. Typical rating outputs that might be selected include

- maturity level and/or capability level ratings
- PA Satisfaction/Capability Level Profiles
- practice ratings
- an option to use “partially satisfied” as a rating assigned to a PA
- 15504 Process Profile
- discipline-specific ratings (e.g., SE or SW)
- project-level findings or ratings
- other (non-typical) outputs desired

Many of these optional appraisal outputs are discussed further in process 2.4, Generate Appraisal Results.

The sponsor may also request that other products be generated as appraisal outputs. Typical products that might be requested include (see activity 3.1.3, Plan for Next Steps):

- Appraisal Final Report
 - Recommendations for taking action upon the appraisal results
 - Process improvement action plan
-

Implementation Guidance

Goal satisfaction ratings for both specific goals and generic goals of the PAs within the scope of the appraisal are a minimum requirement. Capability and/or maturity level ratings are optional. There is no requirement to report the ratings to the appraisal participants even though ratings are performed. The sponsor has sole authority to decide (in advance) what ratings will or will not be reported, and to whom they will be reported.

While statements of findings are a required output of the method, creating a written report that elaborates on the findings is optional. The sponsor should decide if resources are to be spent creating this artifact. Similarly, the task of creating recommendations to address issues uncovered in the appraisal may require expertise that is not represented on the appraisal team in some cases. The characteristics of the appraised organization and the constraints that shape its improvement program should be carefully considered when making process improvement recommendations.



1.1.5 Obtain Commitment to Appraisal Input

Activity Description	The appraisal sponsor formally approves the appraisal input, and this set of information is placed under change management.
Required Practices	<ul style="list-style-type: none">• Record required information in the appraisal input record.• Obtain sponsor approval of the appraisal input record.• Manage changes to the appraisal input, obtaining sponsor approval of changes.
Parameters and Limits	<p>The appraisal input may be generated incrementally throughout planning, but must be approved prior to the start of data collection. At a minimum, the appraisal input shall provide the information needed to address the following:</p> <ul style="list-style-type: none">• the identity of the appraisal sponsor and the relationship of the sponsor to the organizational unit being appraised• the appraisal purpose, including alignment with business objectives (see activity 1.1.1)• the appraisal reference model scope (see activity 1.1.3)• the organizational unit being appraised (see activity 1.1.3)• the process context, which, at a minimum, includes<ul style="list-style-type: none">- organizational unit size and demographics- application domain, size, criticality, and complexity- high-priority characteristics (e.g., time to market, feature richness, reliability) of the products and services of the organizational unit• appraisal constraints (see activity 1.1.2), which, at a minimum, include<ul style="list-style-type: none">- availability of key resources (e.g., staffing, funding, tools, facilities)- schedule constraints- the maximum amount of time to be used for the appraisal- specific PAs or organizational entities to be excluded from the appraisal- the maximum, minimum, or specific sample size or coverage desired for the appraisal- ownership of appraisal results and any restrictions on their use- controls on information resulting from a confidentiality agreement- non-attribution of appraisal data to associated sources• the identity of the CMMI models used (version, discipline, and representation)

Continued on next page

1.1.5 Obtain Commitment to Appraisal Input (continued)

- Parameters and Limits (continued)**
- the identity and affiliation of the Lead Appraiser who is to be the appraisal team leader for the appraisal
 - the identity and affiliation of the appraisal team members, with their specific appraisal responsibilities
 - the identity (name and organizational affiliation) of appraisal participants and support staff, and their specific responsibilities for the appraisal
 - any additional information to be collected during the appraisal to support the achievement of the appraisal objectives
 - a description of the planned appraisal outputs (see activity 1.1.4), including ratings to be generated
 - anticipated follow-on activities (e.g., reports, appraisal action plans, re-appraisal)
 - planned tailoring of SCAMPI and associated tradeoffs, including the sample size or coverage of the organizational unit
 - appraisal usage mode (i.e., Internal Process Improvement, Supplier Selection, Process Monitoring)
-

Optional Practices None.

Implementation Guidance A Lead Appraiser's ability to build and maintain commitment from the sponsor and the members of the sponsoring organization is a major factor contributing to the success of the appraisal. The process of understanding the requirements and constraints should yield a series of agreements that form an input to the appraisal plan. Based on the judgment of the appraisal team leader, these agreements may be covered in a formal (signed) document that forms a basis for future activities. More typically, the appraisal team leader maintains a record of interactions with the sponsor, which are incorporated into the appraisal plan as it is drafted.

The appraisal team leader and the sponsor should have verbal agreement on the items discussed above, and these items should be documented in some way. The formality of the documentation may range from simple meeting minutes maintained by the appraisal team leader, to a more formal Memorandum of Understanding or other vehicle that documents agreements and provides traceability. It is expected that the appraisal plan will be used to document important issues pertaining to requirements.



1.2 Develop Appraisal Plan

Purpose	Document the results of appraisal planning including the requirements, agreements, estimates, risks, method tailoring, and practical considerations (e.g., schedules, logistics, and contextual information about the organization) associated with the appraisal. Obtain and record the sponsor's approval of the appraisal plan.
Entry Criteria	An appraisal sponsor and SCAMPI Lead Appraiser have agreed to proceed with appraisal planning, based on a common understanding of the key parameters that drive the planning process.
Inputs	Documented agreement(s), reflected in the appraisal input, that support a common understanding of appraisal objectives and key appraisal-planning parameters.
Activities	1.2.1 Tailor Method 1.2.2 Identify Needed Resources 1.2.3 Determine Cost and Schedule 1.2.4 Plan and Manage Logistics 1.2.5 Document and Manage Risks 1.2.6 Obtain Commitment to Appraisal Plan
Outputs	<ul style="list-style-type: none">• Approved appraisal plan• Strategy for managing logistics• Strategy for preparing the organization(s)• Schedule• Interview plan• Team assignments
Outcome	The sponsor and appraisal team leader agree on technical and non-technical details for the planned appraisal. The plan is refined in conjunction with performing the other Planning and Preparation phase activities. This agreement is documented and reviewed by affected stakeholders as appropriate.
Exit Criteria	The final appraisal plan is reviewed and approved.

Continued on next page

1.2 Develop Appraisal Plan (continued)

Key Points	Skilled appraisal team leaders will effectively develop and use outputs from the other Planning and Preparation phase activities to achieve clarity of the shared vision necessary to make the tradeoffs and decisions resulting in a final plan. This activity is an important opportunity for the appraisal team leader to demonstrate process discipline, as well as the type of careful planning described in the CMMI model. Experienced appraisal team leaders will leverage data, templates, and assets (developed through their own experience) to improve the completeness and effectiveness of the appraisal plan, recognizing the return on investment that will be obtained through smooth and efficient appraisals.
Tools and Techniques	Tools include an appraisal plan template, samples, and embedded procedural guidance in planning templates. Estimation worksheets and methods for assessing the impact of appraisal constraints are also quite useful.
Metrics	<ul style="list-style-type: none">• Calendar time spanned by the activity• Effort consumed in carrying out the activities of this process• Level and frequency of changes to the appraisal plan
Verification and Validation	<ul style="list-style-type: none">• Comparison of actual effort for this activity with historical data accumulated by the appraisal team leader• Review of the appraisal plan by affected stakeholders• Sponsor's approval of the plan
Records	<ul style="list-style-type: none">• Estimation worksheets (if used)• Appraisal plan (see activity 1.2.6 for a detailed list of plan contents)
Tailoring	<ul style="list-style-type: none">• In some applications, planning templates and procedures in routine use within the organization can be adapted to the needs of the appraisal. This aids in communication as well as local ownership of the process.• A structured planning workshop may be of benefit for organizations with limited appraisal experience. Such a workshop is a valuable opportunity to discover risks as well as mitigation strategies.

Continued on next page

1.2 Develop Appraisal Plan (continued)

Interfaces with Other Processes

The appraisal plan will guide and define the execution of the appraisal such that it is in concert with the business needs and constraints. An initial plan can be generated immediately following consultation with the sponsor. Further refinement is done as detailed planning occurs and new information comes to light in executing appraisal planning and preparation. A final appraisal plan must be completed prior to the completion of process 1.5, Prepare for Collection of Objective Evidence. Typically, resources, method tailoring, model-related decisions, and a planned list of outputs are finalized early on, while cost, schedule, and logistics are finalized later in the Plan and Prepare for Appraisal phase.

The appraisal input is a necessary input to the appraisal-planning process. While it may not be necessary to formally separate the requirements analysis activities from the activities described in this section, prior understanding of the appraisal requirements is a necessary input to this process. The plan for the appraisal provides an important vehicle for

- documenting agreements and assumptions
- establishing and maintaining sponsorship
- tracking and reporting the performance of the appraisal process
- reinforcing commitments at key points in the appraisal process

The distinction between the appraisal input and appraisal plan is intended to separate the key appraisal requirements and strategic objectives, which require high sponsor visibility and change control approval, from the tactical planning details necessary to implement and satisfy these objectives. While sponsor visibility into the appraisal plan is necessary, revisions are typically low-level implementation details and do not ordinarily require sponsor re-approval. In practical use, the appraisal input is often packaged as a component of the appraisal plan, and a single sponsor signature can serve as approval for both.

Summary of Activities

This process is composed of six activities summarized here and described below. The scope of the appraisal is defined in terms of (a) the portion of the CMMI model that will be investigated and (b) the bounds of the organizational unit for which the results can be considered valid (e.g., a project, a product line, an operating division, a business unit, an entire global enterprise). Method-tailoring choices are made to most effectively achieve appraisal objectives within defined constraints of time, effort, and cost. The resources required to carry out the appraisal are identified. The cost and schedule are negotiated and recorded. The details of logistics, particularly for the on-site period, are documented. Risks and risk-mitigation plans are identified and documented. Completion of these activities results in a well-defined, achievable appraisal plan.



1.2.1 Tailor Method

- Activity Description**
- Tailoring of SCAMPI includes
- selection of choices (if any) within the Required Practices
 - setting parameters that are allowed to vary within the Parameters and Limits
 - inclusion of Optional Practices

Because SCAMPI is designed to apply to a wide range of appraisal applications, the tailoring activity is one that deserves careful and thoughtful attention.

Using “partially satisfied” and choosing to do the appraisal in “verification” or “discovery” mode are explicit selectable tailoring options. This document is designed to clearly indicate which aspects of the method are required and which are tailorable. The Parameters and Limits and Optional Practices sections of each activity description provide discussions of tailoring options, in context.

In addition, the appraisal usage mode will determine some tailoring choices.

- Required Practices**
- Review and select tailoring options within the Required Practices in each activity.
 - Review and set parameters within acceptable limits, where variation is expected.
 - Review and select appropriate Optional Practices.
 - Ensure that the tailoring decisions are self-consistent and that they are appropriate in light of the appraisal objectives and constraints.
 - Document the tailoring decisions made.
-

Parameters and Limits

The structure of the MDD clarifies which SCAMPI features are required, either as a direct derivative of ARC requirements or as SCAMPI requirements. Parameters and Limits sections define the allowable variation within these method requirements. Tailoring guidance and Implementation Guidance are provided to assist with tuning the method to fit sponsor objectives and appraisal constraints. Method tailoring and implementation options must be selected and implemented in a way that does not violate SCAMPI Required Practices.

Continued on next page

1.2.1 Tailor Method (continued)

Optional Practices

Provide the sponsor with more than one candidate scenario for the appraisal, and help them select among the options.

Alternatively, the appraisal team leader may define a tailored instance of the method and propose it to the sponsor for approval or negotiate some of the details.

Implementation Guidance

This appraisal method offers a wide variety of choices that allow the appraisal team leader and sponsor to select appraisal features that best address appraisal and business objectives. The SCAMPI Implementation Model is an asset provided to Lead Appraisers by the CMMI Steward that assists with understanding SCAMPI tailoring and implementation choices.

Method tailoring is directly related to the organizational scope and model scope decisions. Most of the allowable tailoring options flow logically from these decisions when taken in context of the appraisal objectives and constraints. Tailoring decisions typically affect the appraisal risk. Typical tailoring choices that significantly impact appraisal planning include

- CMMI model PAs encompassed by the appraisal
- specification of the organizational unit to be appraised
- number, experience, skills, and affiliation (e.g., internal/external) of appraisal team members
- data collection, analysis, and validation approaches to be utilized including supporting work aids and tools
- effort invested by the organization and the appraisal team in preparation, including pre-on-site data collection and analysis
- time spent on site

Experienced appraisal team leaders will provide a well-defined approach to ensure that the appraisal objectives are achieved in an efficient and effective manner. Experienced sponsors will require a well-defined approach to ensure an acceptable level of risk in meeting objectives within the constraints. The appraisal plan documents the method-tailoring decisions and their rationale, and the associated method variations and techniques that will be employed.



1.2.2 Identify Needed Resources

Activity Description	This activity is concerned with the identification and estimation of resources needed to carry out the appraisal. Resources include personnel, facilities, tools, and access to information.
Required Practices	<ul style="list-style-type: none">• Identify appraisal team members.• Identify appraisal participants.• Identify equipment and facilities.• Identify other appraisal resources needed.• Document resource decisions in the appraisal plan.
Parameters and Limits	<p>The level of detail in the identification of needed resources must be sufficient to support the creation of the appraisal plan. For example, the appraisal team leader must identify</p> <ul style="list-style-type: none">• the names of people who are candidates for interviews or appraisal team membership• the organizational or project affiliation of these people• the location, seating capacity, and configuration of rooms to be used by the team• specific equipment needed (e.g., overhead projector, laptop projector, video-conferencing)
Optional Practices	<p>Several months before the appraisal, tour the facility where the appraisal will be held.</p> <p>Assign an individual from the appraised organization to carry out the duties of the Organizational Unit Coordinator (administrative and logistical support; see activity 1.3.2.)</p>

Continued on next page

1.2.2 Identify Needed Resources (continued)

Implementation Guidance Appraisal resources are typically defined early in the appraisal-planning process. Identifying resources goes hand in hand with estimating appraisal cost and schedule (see activity 1.2.3), and these may be iteratively refined. Tradeoffs are routinely made in light of the appraisal objectives and constraints.

The appraisal sponsor or senior site manager may identify candidate appraisal team members and appraisal participants. Review of the organizational unit structure or other site-specific information can also be useful for this. Initially, participants can be specified in terms of roles or responsibilities, with specific names to be determined later. Process 1.3 contains additional guidance on selecting appraisal team members.

Equipment and facilities are often negotiated with the organizational unit where the appraisal on-site activities will be performed, but sometimes these must be acquired. A room for dedicated use by the appraisal team is usually necessary for private discussions and to protect the confidentiality of appraisal data. Ideally, this is separate from the other rooms where interview sessions are held.

The availability of computing resources, such as computers, printers, and networks, is a key consideration that should be planned and understood. Access to special tools or applications may also be needed.



1.2.3 Determine Cost and Schedule

Activity Description	A top-level cost breakdown and schedule are developed and included in the plan.
Required Practices	<ul style="list-style-type: none">• Estimate the duration of key events as a basis for deriving a comprehensive schedule.• Estimate the effort required for the people participating in the appraisal.• Estimate the costs associated with using facilities and equipment (as appropriate).• Estimate the costs for incidentals (e.g., travel, lodging, meals) as appropriate.• Document detailed schedule estimates in the appraisal plan.• Document detailed cost estimates in the appraisal plan.
Parameters and Limits	<p>Effort estimates should be developed not only for the appraisal team, but also for the expected participants within the organizational unit (e.g., interviewees, respondents to instruments administered, attendees at briefings, support staff).</p> <p>Scheduling for each day of the appraisal is required.</p>
Optional Practices	None.

Continued on next page

1.2.3 Determine Cost and Schedule (continued)

Implementation Guidance Cost and schedule may be developed top down based upon sponsor objectives and constraints, bottom up based upon results of other planning and preparation processes and activities, or more generally using a combination of the two approaches. Scheduling the events and activities of the appraisal is an ongoing logistical task that requires the coordination of many different groups of individuals. Determining and communicating a schedule for the appraisal, and maintaining ongoing visibility as the details take form, is the primary responsibility of the appraisal team leader. The Organizational Unit Coordinator is expected to provide support in this task, and the appraisal team leader typically selects the person who plays that role with this duty in mind.

The needs of the sponsor for appraisal outputs of a specified quality fulfilling a specified purpose, balanced against the resources available to conduct the appraisal, will determine the schedule constraints. Schedule and cost need to be considered for the entire span of the appraisal activities. The tradeoff between time spent in preparation versus time spent on site will therefore be a significant factor, as will post-on-site reporting activities.

Organizational costs for preparing and supporting appraisals can be reduced by gathering and maintaining objective evidence for each project instance. In addition to providing an effective mechanism for monitoring the process implementation and improvement progress of each project, this enables the ready availability and reuse of objective evidence for subsequent appraisals.

While the schedule for the appraisal will be shared with a fairly wide audience, the cost of the appraisal (or elements within the appraisal) is often kept from wide view, due to the potentially sensitive nature of this information.



1.2.4 Plan and Manage Logistics

Activity Description	The logistical details of the on-site portion of the appraisal are negotiated and documented. The appraisal team leader, supported by the Organizational Unit Coordinator, manages planning tasks that document and communicate logistical arrangements. Checklists and action item tracking mechanisms are very important structures used to manage these tasks.
Required Practices	<ul style="list-style-type: none">• Document logistical schedules and dependencies.• Maintain communication channels for providing status.• Assign responsibilities for tracking logistical issues.
Parameters and Limits	Effective planning depends on anticipating a variety of logistical issues that may occur during the appraisal. Issues that are sometimes overlooked include <ul style="list-style-type: none">• identifying hotels for people traveling to the appraisal• providing workstation support• ordering meals• interacting with facilities staff on site• meeting security/classification requirements• providing badges or arranging for escorts in limited-access facilities
Optional Practices	None.
Implementation Guidance	Every experienced appraisal team leader knows the value of thorough logistical planning and tracking. The time-critical nature of on-site appraisal activities makes it very difficult to manage last-minute changes in important details such as the following: <ul style="list-style-type: none">• availability of conference rooms and meeting rooms of the appropriate size• access to rooms, equipment, and supplies needed for administrative tasks• transportation and/or lodging for team members or the remote members of the organizational unit• food and other amenities required for adequate working conditions• communication channels and back-up staff to support the team on site



1.2.5 Document and Manage Risks

Activity Description As with any project containing dependencies among events, people, and other resources, risk management is an important ingredient to success. The appraisal team leader is responsible for documenting and communicating risks and associated mitigation plans to the sponsor and appraisal team members.

Required Practices

- Identify appraisal risks.
- Develop mitigation plans for key appraisal risks, and implement these plans as necessary.
- Keep the appraisal sponsor and other stakeholders informed of the appraisal risk status.

Parameters and Limits The risks and mitigation plans identified through conducting this activity are required elements of the appraisal plan (see Parameters and Limits for activity 1.2.6). Most Lead Appraisers include a section titled “Risk Management” in the appraisal plan. The level of effort devoted to risk-management activities is something the appraisal team leader must adjust to fit the situation at hand.

Optional Practices None.

Implementation Guidance The appraisal plan is used to document and track risks to the successful conduct of the appraisal. As with the requirement to address logistical issues during planning, there are no minimum guidelines to be met other than the requirement that the plan include identified risks and planned mitigation strategies.

The appraisal team leader is responsible for keeping the appraisal sponsor informed of risk-management activities so that, if needed, timely sponsor intervention is possible to ensure the achievement of appraisal objectives.



1.2.6 Obtain Commitment to Appraisal Plan

Activity Description Formal sponsor commitment is obtained to the appraisal plan. The appraisal plan constitutes a “contract” between the appraisal sponsor and the appraisal team leader, so it is vital that this agreement be formal.

Required Practices

- Document the appraisal plan.
- Review the appraisal plan with the sponsor and secure the sponsor’s approval.
- Provide the appraisal plan to relevant stakeholders for review.

Parameters and Limits Required contents of the appraisal plan include the following, at a minimum:

- the appraisal input (see activity 1.1.5)
- the activities to be performed in conducting the appraisal
- resources needed for conducting the appraisal (see 1.2.2)
- cost and schedule estimates for performing the appraisal (see activity 1.2.3)
- appraisal logistics (see activity 1.2.4)
- risks and mitigation plans associated with appraisal execution (see activity 1.2.5)
- the criteria to verify that the requirements of ISO/IEC 15504 have been met, if requested by the appraisal sponsor

There must be a signature block for the appraisal team leader and the sponsor to indicate in writing their commitment to the plan. If minor updates are made to the plan, signatures do not have to be obtained again except when one or more elements of the appraisal input have been changed.

At a minimum, the appraisal team members are considered relevant stakeholders and should receive a copy of the approved appraisal plan.

Continued on next page

1.2.6 Obtain Commitment to Appraisal Plan (continued)

Optional Practices Use a signature block for relevant stakeholders to indicate in writing their commitment to the plan (i.e., each team member signs the plan).

Implementation Guidance While sponsor visibility into the appraisal plan is necessary, revisions are typically low-level implementation details and do not ordinarily require sponsor re-approval. This is in contrast to the appraisal input, which contains strategic, key appraisal requirements, objectives, and constraints. Revisions to the appraisal input must be approved by the sponsor. In practical use, the appraisal input is often packaged as a component of the appraisal plan, and a single sponsor signature can serve as approval for both. The separation of the appraisal input and appraisal plan is intended to provide an appropriate level of sponsor visibility and approval, while leaving appraisal team leaders the flexibility to refine the low-level details necessary to complete thorough appraisal planning.

The use of the term “relevant stakeholder” in the context of appraisal planning is intended to be interpreted broadly to include as many of the participants and other affected parties as feasible.



1.3 Select and Prepare Team

Purpose	Ensure that an experienced, trained, appropriately qualified team is available and prepared to execute the appraisal process.
Entry Criteria	<ul style="list-style-type: none">• Appraisal requirements have been documented (at least in draft form).• Appraisal constraints are understood and documented (at least in draft form).• The appraisal plan is defined (at least in draft form).
Inputs	<ul style="list-style-type: none">• Appraisal requirements and constraints (in draft or final form)• Appraisal plan (in draft or final form)• Team training materials
Activities	1.3.1 Identify Team Leader 1.3.2 Select Team Members 1.3.3 Prepare Team
Outputs	<ul style="list-style-type: none">• Training records• Appraisal team member assignments and qualifications• A prepared appraisal team that has completed<ul style="list-style-type: none">- appraisal method training- reference model training- team-building activities- team orientation regarding appraisal
Outcome	The successful completion of this process results in an experienced, trained, and oriented team ready to execute the appraisal. The appraisal team members have acquired the necessary knowledge to play their roles, or their previous knowledge is confirmed to be satisfactory. The appraisal team leader has provided opportunities to practice the skills needed for each person to play his or her role, or has confirmed that these skills have already been demonstrated in the past. The team members have been introduced to one another, and have begun to plan how they will work together.
Exit Criteria	<ul style="list-style-type: none">• The prepared team is committed to the appraisal.• Training has been provided and its results recorded.• Remediation of knowledge/skill shortfalls has been completed (if needed).

Continued on next page

1.3 Select and Prepare Team (continued)

Key Points	Whether the appraisal team leader trains an intact team or forms a team from a corps of experienced team members, the responsibility to ensure that the team is ready to succeed rests with the appraisal team leader.
Tools and Techniques	<p>Training course material is available from the CMMI Steward for training teams. This should be tailored or supplemented by the appraisal team leader based on the appraisal context or degree of team member experience. Case studies and exercises are recommended to reinforce the situations team members are likely to encounter during the appraisal.</p> <p>Other ways of accomplishing this activity may draw on one or more of the following:</p> <ul style="list-style-type: none">• providing supplementary training to previously experienced team members, so that the operational details of the approach used will be familiar• training a cadre of team members and keeping their knowledge and skills up-to-date, as part of an overall program of appraisals
Metrics	<ul style="list-style-type: none">• Summary of team member qualifications• Effort and calendar time expended to accomplish training• Trainee ratings of instructional materials and approach (if applicable)• Achievement of milestones for remedial activities (if applicable)
Verification and Validation	<ul style="list-style-type: none">• Sponsor and appraisal team leader approval of team membership and preparation• Results of exams used to demonstrate training effectiveness (if used)• Feedback from team members on their readiness to perform their role(s)
Records	<ul style="list-style-type: none">• Team member contact information• Training records (if applicable)• Feedback provided by trainees (if applicable)• Team qualification summary (recorded in appraisal plan)
Tailoring	<ul style="list-style-type: none">• Case study materials provide a variety of options for expanding the team training course to add emphasis where more is desired.• Experienced appraisal team leaders have had success conducting role-plays and simulated appraisal activities without case studies as well.• When assembling a team of already-trained members, it is important to conduct team-building activities to ensure team cohesion. Many team building exercises are available for this purpose• Team size, skills, and composition are tailoring options in the method.

Continued on next page

1.3 Select and Prepare Team (continued)

Interfaces with Other Processes

This process includes selecting and preparing the appraisal team. It may occur after obtaining sponsor commitment to the appraisal input. The appraisal plan should be available, at least in draft form, as a necessary input (see activity 1.2.6 for contents). Selected appraisal team members may provide input into further definition of the appraisal planning. Appraisal team training may provide an initial means to obtain a preliminary understanding of the appraised organization's operations and processes. If available, the organizational unit's PII database is a useful resource for orienting the appraisal team on organizational characteristics, such as the application domain, the organizational structure, the process improvement structure, and approaches for reference model implementation.

Summary of Activities

The appraisal team is a cohesive unit of trained and capable professionals, each of whom must meet stringent qualifications. An appraisal team leader is selected to plan and manage the performance of the appraisal, delegate appraisal tasks to team members, and ensure adherence to SCAMPI requirements. Appraisal team members are selected based on defined criteria for experience, knowledge, and skills to ensure an efficient team capable of satisfying the appraisal objectives. Training is provided to ensure proficiency in the reference model and appraisal method.



1.3.1 Identify Team Leader

Activity Description The appraisal sponsor is responsible for selecting an appraisal team leader who has the appropriate experience, knowledge, and skills to take responsibility for and lead the appraisal. By definition an appraisal team leader must be a SCAMPI Lead Appraiser, authorized by the SEI Appraiser Program, and must be a member of that program in good standing. The SEI Appraiser Program is described on the SEI Web site at <<http://www.sei.cmu.edu/managing/app.directory.html>>. The appraisal team leader is responsible for ensuring that the appraisal is conducted in accordance with SCAMPI requirements, with tailoring to meet appraisal objectives and constraints within allowable bounds defined by the method.

- Required Practices**
- Select an authorized SCAMPI Lead Appraiser to serve as the appraisal team leader.
 - Verify the qualifications of the appraisal team leader (experience, knowledge, and skills).
-

Parameters and Limits The appraisal team leader must be an SEI-authorized SCAMPI Lead Appraiser in good standing. This can be verified on the Web or by contacting the SEI CMMI Steward directly.

There can be only one official appraisal team leader on any given appraisal. The appraisal team leader has sole discretion to delegate important tasks to appraisal team members, but cannot delegate leadership responsibility or ultimate responsibility for the successful completion of the appraisal. The inclusion of multiple Lead Appraisers on a team for a given appraisal can be a strong asset for the leader of that team. However, the single designated appraisal team leader must perform the leadership role and manage the appraisal process.

Optional Practices In some uses of SCAMPI, representatives of the appraisal sponsor may perform a substantial part of the appraisal team leader's responsibilities in advance of the initial identification of an appraisal team leader. Infrastructures established to manage Supplier Selection, for example, may employ standard acquisition processes that have well-understood interfaces with the appraisal process.

Continued on next page

1.3.1 Identify Team Leader (continued)

Implementation Guidance SCAMPI Lead Appraisers, by definition, will have participated on a minimum of three appraisals (two as an appraisal team member and one as an appraisal team leader). These requirements are outlined in the SEI Lead Appraiser program. An additional consideration impacting team experience requirements, however, is the appraisal usage mode for SCAMPI. Additional experience may be necessary for the appraisal team leader and/or appraisal team members if the appraisal is for Supplier Selection and/or Process Monitoring or if it will focus heavily on one of the other available disciplines or environments, such as acquisition or Integrated Product and Process Development. Similarly, if the appraisal will be used in a high maturity organization (maturity levels 4-5 or capability levels 4-5), special experience, training, and/or expertise (e.g., statistical process control) may be necessary for that specific appraisal.

Appraisal team leader responsibilities are defined and described throughout the SCAMPI MDD, but a summary overview of these responsibilities includes the following:

- Confirm the sponsor's commitment to proceed with the appraisal.
- Ensure that appraisal participants are briefed on the purpose, scope, and approach of the appraisal.
- Ensure that all appraisal team members have the appropriate experience, knowledge, and skills in the appraisal reference model and in SCAMPI.
- Ensure that the appraisal is conducted in accordance with the documented SCAMPI method.
- Verify and document that the appraisal method requirements have been met.

The appraisal team leader may be selected at any time in the appraisal-planning phase; preferably, the appraisal team leader is selected upon initiation of appraisal activities so that he or she may participate in analyzing the requirements with the appraisal sponsor. In any event, the appraisal team leader should be identified in time to (a) review and approve the appraisal plan with the appraisal sponsor prior to beginning the on-site portion of the appraisal, and (b) ensure adequate planning and the preparation of appraisal team members.



1.3.2 Select Team Members

Activity Description This activity involves identifying available personnel, assessing their qualifications, and selecting them to become appraisal team members. It may occur after obtaining the sponsor's commitment to conduct the appraisal and may provide input to the appraisal planning.

Required Practices

- Ensure that minimum criteria for individual team members are met.
- Ensure that minimum criteria for the team as a whole are met.
- Document the qualifications and responsibilities of team members in the appraisal input.

Parameters and Limits The minimum acceptable team size for a SCAMPI appraisal is four people (including the team leader). The maximum recommended team size is nine.

All team members must have previously completed the SEI-licensed Introduction to CMMI course, delivered by an instructor who is authorized by the SEI.

Team members' training in the appraisal method is discussed in activity 1.3.3, Prepare Team.

With regard to engineering field experience, the team (as a group) must have an average of at least 6 years of experience, and the team total must be at least 25 years of experience, in each of the disciplines to be covered in the appraisal.

With regard to management experience, the team (as a group) must have a total of at least 10 years of experience, and at least one team member must have at least 6 years of experience as a manager.

The team should, in aggregate, have representative experience in the life cycles in use within the appraised organization. For any given life-cycle phase, at least two members of the team should have experience as a practitioner.

Team members should not be managers of one of the selected projects or be within the direct supervisory chain of any of the anticipated interviewees.

Continued on next page

1.3.2 Select Team Members (continued)

Optional Practices

Although not required in the Parameters and Limits section above, the following are considered recommended best practices and should be employed whenever feasible:

- Each member should have good written and oral communication skills, the ability to facilitate the free flow of communication, and the ability to perform as team players and negotiate consensus.
- At least half of the team members should have participated in a previous process appraisal.
- Team members should be perceived by the appraisal sponsor as credible.

Additional appraisal team member selection considerations:

- Consider the personal characteristics of individual team members (e.g., communication preferences, personality types) and how these may affect the dynamics in a team environment.
 - Use one or more authorized Lead Appraisers as team members.
-

Implementation Guidance

Appraisal team members are selected to provide a diverse set of qualified professionals with the appropriate experience, knowledge, and skills to make reasoned judgments regarding implementation of the reference model.

The accuracy and credibility of the appraisal results depends greatly on the capability, qualifications, and preparation of the appraisal team members. In addition to the qualifications described above, other factors that may affect the performance of the team or reliability of appraisal results should be considered. Appraisal constraints, such as security classification, may result in additional criteria for team member selection.

The selected appraisal team members and their organizational affiliation and qualifications (individually and in aggregate) are documented in the appraisal plan. Appraisal team members are typically selected from a pool of qualified individuals provided by the appraisal sponsor or his/her designee. The appraisal team leader is the final authority on acceptance of appraisal team members, and is responsible for ensuring their qualifications and suitability for the appraisal purpose.

Situations where a conflict of interest may arise should be avoided. Team members who manage people or processes in the organization may struggle with their ability to be objective. Team members who are directly impacted by the appraisal outcome may be distracted by the potential consequences of the decisions they contribute to on the appraisal team.



1.3.3 Prepare Team

**Activity
Description**

The appraisal team leader is responsible for ensuring that appraisal team members are sufficiently prepared for performing the planned appraisal activities. This includes familiarity with the reference model, SCAMPI, the appraisal plan, organizational data and characteristics, and the tools and techniques to be used during the appraisal. Roles and responsibilities are assigned for appraisal tasks. Team building exercises are used to practice facilitation skills and reach unity in understanding the team objectives and how they will be satisfied.

All team members are expected to observe strict rules for confidentiality, the protection of proprietary or sensitive data, and the non-attribution of information to project participants. Non-disclosure statements are often used to formalize these understandings.

**Required
Practices**

- Ensure that appraisal team members have received reference model training.
 - Provide appraisal method training to appraisal team members or ensure that they have already received it.
 - Provide for team building and establishing team norms.
 - Provide orientation to team members on appraisal objectives, plans, and their assigned roles and responsibilities.
-

Continued on next page

1.3.3 Prepare Team (continued)

**Parameters
and Limits**

Model training must be provided using the standard Introduction to CMMI course, delivered by an instructor who is authorized by the CMMI Steward.

Method training may be delivered in one of two ways:

1. method training specific to the appraisal at hand
2. method training delivered to a large group of potential future team members who are not currently engaged in an appraisal

Method training delivered to an intact team must be at least two days in duration and must emphasize the situations likely to be encountered by team members during the appraisal. This training will not necessarily cover all variants in the application of SCAMPI.

Method training delivered to groups of potential future team members must cover the complete set of tailoring options and allowable variations for the method to prepare them for a range of situations they are likely to encounter on future appraisals. The SEI Appraiser Program specifies additional requirements about delivering training to people who are not already members of an appraisal team.

Team members who have previously been trained as a member of a prior appraisal team are not automatically qualified to participate on a subsequent appraisal without first attending method training. In such cases, the appraisal team leader is required to understand the nature of the training delivered previously and the adequacy of that training for the appraisal at hand. This requires that the previous appraisal be compared with the planned appraisal. For example, if the team member participated in an appraisal focused only on software engineering, using the continuous representation, and the planned appraisal is focused on SE/SW/IPPD using a staged representation, there may be some important new concepts to cover with that team member.

There must be at least one event where the team gathers as a group for the purpose of establishing team norms and operational decisions about how the team will work for the appraisal at hand.

Continued on next page

1.3.3 Prepare Team (continued)

Optional Practices Some organizations have established an “organic” capability to perform appraisals with very limited preparation effort, through the use of a pool of trained appraisal team members. Drawing from an established group of experts, who are accustomed to working together, clearly provides a savings over time for organizations that conduct frequent appraisals.

Implementation Guidance The team training event is a good place to review the appraisal plan with appraisal team members, having sent it to them in advance of their arrival. This event provides the orientation for the entire appraisal that all appraisal team members need to execute their roles appropriately. This also is in keeping with the “Provide appraisal plan to relevant stakeholders for review” required practice in activity 1.2.6.

Additionally, the team training event is a primary opportunity to conduct activity 1.5.1, Perform Readiness Review. The assembled, trained appraisal team can then appropriately assess the organization’s readiness for the appraisal and validate the reasonableness of appraisal estimates.

Implementation Guidance A typical model training course is delivered in two-and-a-half to three days. Although training in either model representation (staged or continuous) is allowable, it is recommended that this training be provided for the model representation to be used during the appraisal. The successful completion of reference model training should precede training in the appraisal method. *Training in the Reference Model* There is no “aging” requirement for when this model training was received, but the appraisal team leader is responsible for ensuring that each team member has adequate reference model understanding, and for taking remedial action if necessary. Attendance at model training needs to be recorded by the training instructor and provided to the CMMI Steward, in accordance with the terms of the instructor authorization.

For appraisals that include higher levels (i.e., maturity/capability levels 4 and 5) team members may benefit from receiving additional training on this subject matter. The Intermediate Concepts of CMMI course, a course on Statistical Process Control, and/or other advance topics may be of use for this added level of preparation.

Continued on next page

1.3.3 Prepare Team (continued)

Implementation Guidance A typical delivery of appraisal team training might take two-and-a-half to three days. More or less time may be necessary depending on the relative experience of the appraisal team members.

Training in the Appraisal Method

Exercises in appraisal techniques and team development are used to reinforce the skills that will be important during conduct of the appraisal. It is recommended that exercises be used that are appropriate for the organizational unit being appraised. Where sufficient organizational artifacts exist, “live” data can be collected and used in training exercises where appropriate. Just-in-time training can also be used to re-emphasize method concepts at appropriate points in the appraisal process during which the skills will be utilized.

Appraisal team training materials should be tailored to fit team needs and objectives of the specific appraisal. Tailoring provides opportunities to

- provide insight into the context, objectives, and plans of the particular appraisal
- communicate team members’ assigned roles and responsibilities
- identify tailoring of SCAMPI for the upcoming appraisal
- acquaint the team with the organizational unit’s characteristics and documentation
- focus on skills that may be more critical to the upcoming appraisal, such as the ability to facilitate interviews or the ability to identify alternative practices

It is recommended that this training be provided within 60 days of the appraisal. The appraisal team leader typically provides method training, but other delivery options are also acceptable (as described above). Although alternative training options can provide some advantages and efficiencies for method training, there are also potential consequences that might be felt by the appraisal team leader on a given appraisal, such as poor training quality or readiness of team members. Regardless of how method training is delivered to the team members, opportunities for team building should be provided to coalesce the team and bring the team up to speed on the specifics of the appraisal being planned.

Implementation Guidance Method training and team building provide good opportunities to establish team familiarity with the appraisal plan. This includes such items as appraisal objectives, organizational scope, reference model scope, and the schedule, resources, and constraints for conducting the appraisal. Team member input can be obtained to refine or complete the contents of the appraisal plan.

Familiarization with the Appraisal Plan

Continued on next page

1.3.3 Prepare Team (continued)

Implementation Guidance Analysis of the objective evidence provided by the appraised organization, such as questionnaire responses or worksheets summarizing objective evidence, can be accomplished following or as an integrated part of appraisal team preparation and training.

Analysis of Objective Evidence

Team members should become familiar with the instruments (e.g., questionnaires, PII database) to be used as data collection sources during the appraisal. Demonstrations or exercises using the data collection tools and methods planned for the appraisal should be used to provide appraisal team members with an opportunity to practice techniques for data recording, verification, and analysis. This may include mechanisms such as wall charts, spreadsheets, or data reduction tools. The more familiarity and comfort that can be obtained with these tools in advance, the greater the savings in team efficiency during the appraisal on-site phases.

Continued on next page

1.3.3 Prepare Team (continued)

Implementation Guidance The appraisal team leader should assign and explain team member roles and responsibilities to be performed during the appraisal. Typical roles to be assigned include:

Roles and Responsibilities *Organizational Unit Coordinator:* The Organizational Unit Coordinator handles on-site logistics and provides technical, administrative, and logistical support to the appraisal team leader. This usually includes activities such as coordinating schedules, notifying participants, arranging adequate facilities and resources, obtaining requested documentation, and arranging catering. He or she may also coordinate or provide clerical support to the team. This role is often assigned to one or more members of the organizational unit. The Organizational Unit Coordinator may be one of the appraisal team members, or this role may be assigned to other site personnel.

Librarian: The librarian manages the inventory of appraisal documents, coordinates requests for additional documentation evidence, and returns documents at the end of the appraisal. This role can be fulfilled by an appraisal team member or by a member of the support staff.

Process Area Mini-Teams: Mini-teams take the lead for data collection in assigned PAs. They ensure that information collected during a data gathering session covers their PAs, request additional information needed relative to their PAs, and record the work performed by individual appraisal team members pertaining to their PAs.

Mini-teams typically consist of two or three members. Mini-team assignments can be made based on several factors, including

- related PAs (e.g., PA categories)
- composition mix of mini-team members (e.g., discipline experience, appraisal experience)

Facilitator: The facilitator conducts interviews, asking questions of interview participants.

Timekeeper: The timekeeper is responsible for tracking time and schedule constraints during interviews and other activities.

Observer: Due to the confidentiality required during an appraisal and the cohesiveness needed to participate in appraisal activities, observers are not permitted to participate in the appraisal processes. The only exception is an observer who is authorized by the CMMI Steward to observe a candidate Lead Appraiser's performance as appraisal team leader or to perform an audit as part of the quality audit function of the Steward.



1.4 Obtain and Analyze Initial Objective Evidence

Purpose	Obtain information that facilitates site-specific preparation and an understanding of the implementation of model practices across the organizational unit. Identify potential issues, gaps, or risks to aid in refining the plan. Strengthen understanding of the organization's operations and processes.
Entry Criteria	<ul style="list-style-type: none">• Appraisal input received• Sponsor authorization to proceed• Availability of practice implementation data for organizational unit
Inputs	<ul style="list-style-type: none">• Practice implementation data for organizational unit• Identified participants
Activities	1.4.1 Prepare Participants 1.4.2 Administer Instruments 1.4.3 Obtain Initial Objective Evidence 1.4.4 Inventory Objective Evidence
Outputs	<ul style="list-style-type: none">• Completed instruments• Data analyses results (data summaries, questionnaire results, etc.)• Identification of additional information needed• Prepared participants• Initial set of objective evidence
Outcome	<ul style="list-style-type: none">• Initial objective evidence has been collected, organized, and recorded.• Potentially important areas of needed information have been noted.• The team has a deeper understanding of the organizational unit's operations and processes.• The team is ready to make detailed plans for data collection.
Exit Criteria	<ul style="list-style-type: none">• All objective evidence captured during this activity has been recorded for later use.• High-priority areas for additional data collection have been identified.• The level of sufficiency of the objective evidence to support the appraisal is determined.

Continued on next page

1.4 Obtain and Analyze Initial Objective Evidence (continued)

Key Points	<p>Gather high-leverage objective evidence. The amount of initial objective evidence provided by the organization will determine the proportion of evidence that must be discovered (versus verified) during the appraisal. Maximizing time spent in verification, versus discovery, is a key performance objective for the appraisal process.</p> <hr/>
Tools and Techniques	<ul style="list-style-type: none">• Automated support for questionnaires, including data reduction tools, may be available to make the data analysis activity more efficient.• Breaking into mini-teams to review data related to specific PAs is a way to ensure completeness in the data. <hr/>
Metrics	<ul style="list-style-type: none">• The number of practices for which complete objective evidence is available• The number of questionnaire respondents reported in the Appraisal Record• The calendar time and effort expended for this activity compared to the planned values <hr/>
Verification and Validation	<ul style="list-style-type: none">• Where the team includes members of the appraised organization, these members should be used to help understand the initial objective evidence provided to prevent misinterpretation of terms or special conditions.• Inconsistencies and contradictions among the items provided in initial objective evidence should be identified and recorded for resolution. <hr/>
Records	<ul style="list-style-type: none">• Records of this process include completed and/or summarized questionnaires, profiles, and surveys.• Lists of information needed should be maintained and used as an input to the later data collection activities.• Calendar time and effort expended in this activity should be recorded and compared to the plan. These data will be part of the Appraisal Record. <hr/>
Tailoring	<p>A variety of methods can be used to collect initial data, including</p> <ul style="list-style-type: none">• a site information package prepared by representatives of the organization• a presentation on the process improvement program and its accomplishments• specialized or general questionnaires focused on practice implementation <p>The use of additional instruments is dependent on the results of the analysis of available data and the results of process 1.5, Prepare for Collection of Objective Evidence.</p> <hr/>

Continued on next page

1.4 Obtain and Analyze Initial Objective Evidence (continued)

Interfaces with Other Processes

This process plays a critical role in the planning and preparation processes. The information generated in this process provides the most important opportunity to reset expectations and plans with the appraisal sponsor, if initial assumptions about the availability of objective evidence turn out to be in error. It will also provide the basis of data collection planning.

Summary of Activities

The appraisal team leader works with representatives of the organization to obtain an initial data set that represents an inventory of the objective evidence pertaining to the implementation of each instantiation of each practice within the appraisal scope. This initial data set is first reviewed by the appraisal team leader for a high-level assessment of adequacy and completeness. The appraisal team leader or appraisal team then performs a more detailed analysis to use as input for planning the data collection and verification activities that will occur when they arrive on site. Finally, a record is created that reflects a detailed accounting of any missing objective evidence. This record is used as primary input for the generation of the data collection plan.



1.4.1 Prepare Participants

Activity Description Members of the organization who participate in the appraisal must be informed of their role, and the expectations the sponsor and appraisal team have. This is typically accomplished through a briefing where the appraisal team leader provides an overview of the appraisal process, purpose, and objectives. Specific information about the scheduled events and the locations where they occur is also communicated during this presentation, as well as through ongoing contact between the Organizational Unit Coordinator and the members of the organization.

Required Practices

- Brief appraisal participants on the appraisal process.
- Provide orientation to appraisal participants on their roles in the appraisal.

Parameters and Limits The orientation provided to appraisal participants must occur some time prior to their participation to allow participants to confirm their availability and to prepare for their participation.

The preparation of appraisal participants may be accomplished via video/teleconference if desired.

Continued on next page

1.4.1 Prepare Participants (continued)

Optional Practices Provide orientation on the documentation of PIIs and any specific instruments used, so the appropriate people in the organization can document the initial objective evidence to be used in the appraisal.

Implementation Guidance Depending on the appraisal usage mode (e.g., supplier selection versus internal process improvement), various types of communications may be used. In the internal process improvement usage mode, the importance of management sponsorship within the organization will likely lead the appraisal team leader to work with senior management to help demonstrate commitment to the appraisal process as well as the process improvement work that will follow. In the supplier selection usage mode, the possibility of the same team visiting multiple organizations adds coordination tasks and communication channels as well.

Preparation of appraisal participants should also include informing them of the need to provide accurate and complete information on instruments. In addition to assisting with appraisal accuracy, this can help to ensure sufficient coverage of reference model practices and reduce the amount of time necessary for follow-up interviews. The investment in initial population of complete instruments, such as PIIs, questionnaires, or mapping tables, can be recovered by reduced effort in the reuse of assets for subsequent appraisals.



1.4.2 Administer Instruments

Activity Description	<p>This activity involves the administration of instruments for the appraisal that are additional to the input data (such as process implementation indicators provided by the organization as input to the appraisal). It includes the use of structured techniques and work aids (e.g., surveys, questionnaires, or an objective evidence database) to assist the organizational unit in characterizing their process and supporting objective evidence in terms of model practices.</p> <p>A practice-based questionnaire is also a commonly used instrument during appraisals. Such questionnaires typically have a series of focused questions, each one providing an opportunity for the respondent to answer a closed-ended question about a practice. In addition, the respondent is given an opportunity to write a clarifying comment that serves to elaborate on the closed-ended response.</p>
Required Practices	<p>Administer appraisal instruments for the entry of data by appraisal participants.</p>
Parameters and Limits	<p>The application of this activity to generate instrument data to support the data collection plan is limited to the instruments identified in the Data Collection Plan. Instruments are typically administered by representatives of the appraisal team. The appraisal team leader is responsible for negotiating additional time and resources if the data provided using instruments is incomplete. It is also the responsibility of the appraisal team leader to avoid requesting duplicate data entry on multiple instruments. No organization should be asked to provide the same information in two (or more) formats.</p> <p>Whatever vehicle is used, the resultant data must provide information about the extent of the implementation of model practices in the organizational unit and the sampled projects.</p>

Continued on next page

1.4.2 Administer Instruments (continued)

Optional Practices

Establish an organizational asset (or rely on an existing one) that documents and maintains the traceability of implemented practices to model practices.

Conduct a workshop to document the PIIs for the organization.

Implementation Guidance

The use of instruments to gather written information from members of the organization provides a relatively low-cost data collection technique when done well. Data of this type tend to be most useful when provided early in the appraisal conduct, and can lead to valuable insights about where data may be sought during subsequent data collection events. Since there is limited opportunity for elaboration and “branching” to related topics, responses to instruments can sometimes raise more questions than they answer for the appraisal team member trying to interpret the responses. Furthermore, instruments that contain excessive jargon or complicated terminology may hinder data collection rather than help. Confused respondents will do their best to answer the question they don’t quite understand, and the response is interpreted based on the question that was intended. Having a knowledgeable person present during the administration of an instrument can help mitigate the risk of miscommunication.

One of the attractive features of instruments for the purpose of data collection is that they can be used to establish a “scoring scheme” that reduces the burden of interpretation for the recipient of the data. Such schemes do not exist for SCAMPI, and the use of a shortcut of this type is a violation of the principle that focuses rating judgments on the goals of the PAs in CMMI models. The practices found in CMMI models are Expected Components, while the goals in the models are Required Components. While the satisfaction of a PA goal is predicated on the implementation of practices found in the model (or acceptable alternatives), there is no strict aggregation scheme that allows one to infer goal satisfaction based on practice implementation alone. Rating judgments are based on multiple sources of objective evidence and the reasoned consideration of strengths and weaknesses, in aggregate.

Whenever possible, documents mentioned in the responses to questionnaires or other instruments should be requested for team review early in the process, so that any misleading references will not cause undue confusion later.



1.4.3 Obtain Initial Objective Evidence

Activity Description	<p>The appraisal team leader will request that the organization provides detailed data on the implementation of practices in the organization. The appraisal team leader is free to specify the format to be used and the level of detail to be provided, knowing that anything that is not provided in advance must be collected later in the appraisal process. There are no minimum requirements set by the method with respect to completeness or detail in this initial data set. However, the effort required to conduct a SCAMPI appraisal is a direct function of the amount of data available to the team at the beginning of the process. Before the appraisal outputs can be created, the team will need to verify objective evidence for each instantiation of each practice within the scope of the appraisal. For detailed requirements on the sufficiency of data, refer to process 2.2, Verify and Validate Objective Evidence.</p> <p>The use of a completely populated PII database is desirable but not essential at this stage in the appraisal process. The appraisal team leader must provide an opportunity for the organization to provide it, but will not require it unless the sponsor has agreed that this will be a verification-oriented appraisal (as opposed to a discovery-oriented appraisal).</p> <p>A “mapping” of implemented practices and model practices <i>is</i> required, and may be generated using questionnaires (see activity 1.4.2).</p>
Required Practices	<p>Obtain documentation reflecting the implementation of model practices within the organizational unit and sampled projects.</p>
Parameters and Limits	<p>At a minimum, the organization must provide a list of documents that are relevant to understanding the processes in use in the organizational unit and the sampled projects. This list must be mapped to the model practices that are in the scope of the appraisal.</p>
Optional Practices	<p>A list of terms and important jargon used in the organizational unit may be provided to the team, to aid in communicating with the members of the organization.</p> <p>A complete objective evidence database, which documents the implementation of every model practice (within the scope of the appraisal) in the organizational unit and the sampled projects, may be provided to the team in advance.</p> <p>The use of database tools specifically built to support a process appraisal is highly recommended.</p>

Continued on next page

1.4.3 Obtain Initial Objective Evidence (continued)

- Implementation Guidance** Whether collected through instruments, the review of documents, attending presentations, or interviews, the data used for an appraisal is related to the practices of the reference model. For every practice within the model scope of the appraisal, and for every instance of each practice, objective evidence is used as the basis for appraisal team determinations of the extent to which the practice is implemented. Indicators that substantiate practice implementation include
- direct artifacts, which represent the primary tangible output of a practice. These are typically listed in CMMI models as typical work products. One or more direct artifacts may be necessary to verify the implementation of associated model practices.
 - indirect artifacts, which represent artifacts that are a consequence of performing the practice, but not necessarily the purpose for which it is performed. These are typically things like meeting minutes, review results, or written communications of status.
 - affirmations, which are oral or written statements confirming the implementation of the practice. These are typically validated using interviews, questionnaires, or other means.

Prior to the data collection activities carried out by the appraisal team, an initial data set is usually created by the appraised organization. This data set contains descriptions of the objective evidence available for the team to examine, complete with references to documentation and identification of the personnel who can provide relevant affirmations. This instrument provides the baseline of objective evidence for the appraisal. Most organizations experienced in process improvement will already have this type of data on hand, as they will have used it to track their progress.

Artifacts may be obtained as hard copies, soft copies, or hyperlinks to where these documents reside in a Web-based environment. If hyperlinks are used, the accessibility of artifacts via these links should be verified in the appraisal environment. For example, appraisal team access could be inhibited by invalid references or firewalls.

The initial data set forms the basis for planning the data collection activities, including interviews and presentations on site. Any objective evidence that is not identified in advance of the team's arrival will need to be sought by the team members once they arrive on site. This process of "discovering" whether, and how, the organization has addressed a given practice in the model can be quite time consuming, and it is often difficult to predict how long it will take.



1.4.4 Inventory Objective Evidence

Activity Description	<p>The analysis of the initial data set provides critical new information for the overall planning of the appraisal and forms the basis for the detailed data collection plan that must be developed before the on-site data collection begins. The analysis of initial objective evidence at this stage is focused primarily on the adequacy and completeness of information and the implications for future data collection. The results of this analysis will be the primary basis for determining the extent to which the appraisal will be one of verification or discovery.</p>
Required Practices	<ul style="list-style-type: none">• Examine the initial set of objective evidence provided by the organizational unit.• Determine the extent to which additional information is needed for adequate coverage of model practices.
Parameters and Limits	<p>Information provided by the organizational unit must be detailed enough to understand the extent to which each type of objective evidence (direct artifacts, indirect artifacts, and affirmations) is available for each process instantiation, for each model practice within the scope of the appraisal. This initial review of objective evidence identifies model practices for which the team has</p> <ul style="list-style-type: none">• strong objective evidence• no objective evidence• conflicting objective evidence• anomalous objective evidence• insufficient objective evidence <p>Key documents are identified that can be used to gain insight regarding a number of model practices. These are potential high-leverage documents that may be good candidates for pre-on-site review by team members.</p>
Optional Practices	<p>Review the initial objective evidence with members of the engineering process group.</p>

Continued on next page

1.4.4 Inventory Objective Evidence (continued)

Implementation Guidance Members of the team may choose to summarize the extent of practice implementation at the discretion of the appraisal team leader. However, the objective of this activity is to determine how much additional data team members will need to complete their work. It is recommended that the appraisal team leader establish an expectation with the sponsor that the results of this analysis will form the basis for a revised schedule estimate. If the initial objective evidence is lacking in completeness and detail, the team will be forced to seek more information during the on-site data collection, unless corrective actions are taken before that time.

It is important to keep all stakeholders focused on the fact that SCAMPI is intended as a benchmarking appraisal. This method is not well suited for organizations that have very limited understanding of CMMI. Such organizations may not yet have a clear idea of how the practices described in CMMI models ought to be implemented to meet their specific business needs. Deciding on a reasonable implementation of the practices, and working to ensure that they are enacted on projects throughout the organization, are activities that precede a benchmarking appraisal. A different type of appraisal (Class B or C) is probably going to be more valuable if the objective of the sponsor is to begin the process of understanding what CMMI could mean for the organization. It is not reasonable to schedule a two-week appraisal and expect to collect *all* of the data required for benchmarking during the on-site data collection.

The appraisal team leader often reviews the initial data set provided by the organization prior to assembling the team for its first meeting, to identify areas where additional data will be needed and to assess the feasibility of the planned appraisal schedule. This readiness review should be conducted prior to finalizing the appraisal schedule, and may comprise a “Go/No Go” decision for the appraisal in some situations. The appraisal team will then review the initial objective evidence in more detail (typically toward the end of the team-training event) to begin formulating plans for how missing evidence will be collected, and for the verification of the entire data set. This preliminary readiness review is the basis for the data collection plan, which is described in the next process, Prepare for Collection of Objective Evidence.

Continued on next page

1.4.4 Inventory Objective Evidence (continued)

Implementation The appraisal team leader generates a list of additional information needed.
Guidance The results of the analysis of initial objective evidence are documented as an
(continued) input to the data collection plan. The use of an integrated appraisal tool to annotate the set of initial objective evidence will permit the automated tracking of information needs, and will aid in the compilation of a detailed data collection plan. Where the completeness of initial objective evidence is insufficient to conduct the appraisal under the original schedule, the results of this activity form an important basis for renegotiating the appraisal schedule in some cases.

The adequacy of objective evidence relative to model practices is typically determined using a software tool of some sort, either one built for use on appraisals, or a spreadsheet template. However, paper forms and wall charts may be used if preferred.



1.5 Prepare for Collection of Objective Evidence

Purpose	Plan and document specific data collection strategies, including <ul style="list-style-type: none">• sources of data• tools and techniques to be used• contingencies to manage risk of insufficient data
Entry Criteria	<ul style="list-style-type: none">• Sponsor commitment to proceed with the appraisal has been documented.• Appraisal objectives and constraints have been documented.• Initial data have been received and analysis has been completed.
Inputs	<ul style="list-style-type: none">• Appraisal plan• PIIs for the organizational unit• Initial objective evidence review• Data collection status
Activities	1.5.1 Perform Readiness Review 1.5.2 Prepare Data Collection Plan 1.5.3 Replan Data Collection
Outputs	<ul style="list-style-type: none">• Confirmation that objective evidence collected is sufficient to proceed• Initial data collection plan• Updates to the plan as required
Outcome	Finalized data collection plan. Team members are aware of data needs and the status of initial data available to them.
Exit Criteria	All preparations for data collection by the team have been made and the data collection plan has been documented.

Continued on next page

1.5 Prepare for Collection of Objective Evidence (continued)

Key Points	The data collected is the most important input the team receives. Careful planning, disciplined tracking against the plan, and effective corrective actions are cornerstones to success in this process.
Tools and Techniques	The use of a spreadsheet to record and track the data collection plan is a common technique. A matrix showing the practices of the model, or questions to be asked, arrayed on the vertical axis and the sources of information arrayed on the horizontal axis provides a simple planning and tracking tool. A number of vendor-provided data management tools are available as well.
Metrics	<ul style="list-style-type: none">• Estimated and tracked calendar time and effort for this activity• Planned and actual number of data sources per practice• Planned and tracked number of scripted questions per interview• Planned and tracked number of scripted questions per PA• Percentage of planned coverage achieved, per data collection event or PA
Verification and Validation	The data collection plan should be summarized and reviewed with the team to ensure that appraisal requirements will be successfully implemented if the plan is carried forward. Experienced Lead Appraisers will use historical data to assess the feasibility of (and risks associated with) the data collection plan.
Records	Planned and actual coverage of practices and PAs across the set of data collection activities should be recorded. These data support future estimates and corrective actions during the data collection activities.
Tailoring	<p>Replanning is performed only when the status of the appraisal conduct indicates the need to do so.</p> <p>Additional planning and coordination steps may be necessary in usage modes where data collection activities will occur at geographically distributed sites or across organizational units from different corporations (such as in a Supplier Selection usage mode).</p> <p>SCAMPI allows great flexibility in formulating strategies to accomplish the necessary data collection. The relative emphasis of different data sources, as well as data types, can be tuned to support appraisal objectives relating to buy-in as well as coverage and rigor for important areas.</p>

Continued on next page

1.5 Prepare for Collection of Objective Evidence (continued)

Interfaces with Other Processes

The data collection plan is an essential element of the appraisal plan. The activities described here rely on the results of analyzing the initial objective evidence to derive a plan and set of strategies for accomplishing the data collection needed to meet the objectives of the appraisal. The data collection plan developed through these activities is reviewed and revised on a continual basis throughout the appraisal. Dynamically managing the inventory of data on hand, the list of data needed, and the available data collection opportunities are processes critical to the success of the appraisal.

Summary of Activities

The activities in this process serve to (a) establish the initial planning baseline for the acquisition of objective evidence and (b) update the plan to account for information acquired and unexpected developments. Since SCAMPI is a data-intensive method, the conduct of these activities in accordance with the descriptions provided is essential to the successful use of the appraisal method.



1.5.1 Perform Readiness Review

Activity Description	The available objective evidence is reviewed to determine the extent to which the requested objective evidence has been gathered and whether the evidence is sufficient to proceed or replanning is required.
Required Practices	<ul style="list-style-type: none">• Determine whether the objective evidence for each process instance is adequate to proceed with the appraisal as planned.• Review the feasibility of the appraisal plan in light of the inventory of objective evidence available.
Parameters and Limits	<p>At least one readiness review must be conducted prior to assembling the team on site for data collection.</p> <p>Objective evidence for all PAs within the scope of the appraisal must be reviewed.</p> <p>Objective evidence for all projects sampled to represent the organizational unit must be reviewed.</p>
Optional Practices	Integrating a readiness review with the team training event will allow the appraisal team leader to involve the team in gaining an understanding of the data available to support the appraisal.

Continued on next page

1.5.1 Perform Readiness Review (continued)

Implementation Guidance A summary of the inventory of objective evidence and readiness to proceed should be reviewed with the sponsor or his/her designee. If insufficient objective evidence is available, the appraisal team leader may need to initiate replanning in light of newly discovered constraints (i.e., insufficient data to support the appraisal as planned). Refer to activity 1.1.2, Determine Appraisal Constraints. The criteria for adequacy will depend on where the readiness review occurs in the schedule, and the degree of verification versus discovery that is being sought for the on-site phases of the appraisal.

More than one readiness review is likely to be needed. The first one should be performed early in the planning phase, and the second should be performed once the objective evidence has been gathered and the appraisal is ready to start. This review may be conducted in conjunction with the team-training event.

Thresholds for the sufficiency of data should be established as targets to be met at the readiness review. For example, an 80% threshold may be used to initiate replanning at the final readiness review. That is, the appraisal team leader establishes an expectation with the sponsor that, if more than 20% of the objective evidence is missing at the time of team training, the appraisal will need to be replanned. However, the primary objective is reducing the risk that there will be insufficient objective evidence to make the determinations required by the appraisal plan in the time allotted.

The readiness review is a key event whose impact should not be underestimated. Failure to adequately review the objective evidence available and determine the impact on the appraisal plan can have grave consequences for the appraisal team during the on-site period. This may include long hours, exhaustion, extensive ad hoc data collection (discovery), or the inability to achieve appraisal objectives within defined estimates and constraints.



1.5.2 Prepare Data Collection Plan

Activity Description	<p>The data collection activities are tailored to meet the needs for objective evidence so that the extent of practice implementation can be determined.</p> <p>For practices that have objective evidence, a strategy for verifying that evidence will be formulated.</p> <p>For practices that lack objective evidence, a strategy for discovering that evidence will be formulated.</p> <p>The data collection plan is typically embodied in a number of different artifacts used during the appraisal process. The appraisal plan includes information about the site, projects, and participants involved in the appraisal. This is the highest level of information that helps document and communicate the data collection plan. Detailed information on data collection can be recorded in work aids that manage appraisal data and in the appraisal schedule. A record of “information needed” items is the most detailed representation, while document lists, interview schedules, and the assignment of PA mini-teams help shape the strategy for obtaining the needed data.</p>
Required Practices	<hr/> <ul style="list-style-type: none">• Determine participants for interviews.• Determine artifacts to be reviewed.• Determine presentations/demonstrations to be provided.• Determine team roles and responsibilities for data collection activities.• Document the data collection plan. <hr/>
Parameters and Limits	<p>For every instantiation of every model practice, the data collection plan must specify how, when, and by whom the objective evidence will be verified.</p> <p>For instantiations of model practices that have not been addressed in the initial objective evidence, the data collection plan must specify how the team intends to discover the presence or absence of objective evidence that characterizes the extent of implementation for that practice.</p> <hr/>

Continued on next page

1.5.2 Prepare Data Collection Plan (continued)

Parameters and Limits (continued)

The data collection plan (often documented in a variety of artifacts) includes

- assignment of PAs to team members
 - summary of initial objective evidence provided by the organization
 - identification of highest priority data needs
 - initial allocation of data needs to data-gathering events
 - identification of instruments to be administered
 - identification of participants to be interviewed
 - interview schedule, revised to include more detail
 - identification of a starter set of interview questions
 - identification of documents still needed (if any)
 - risks associated with the sufficiency of the data and the adequacy of the schedule
-

Optional Practices

Review the status of the objective evidence database with members of the appraised organization to elicit additional objective evidence or to expand on the evidence available. This allows the appraisal team leader to validate the data collection plan to some extent.

Continued on next page

1.5.2 Prepare Data Collection Plan (continued)

Implementation Guidance Sources of objective evidence include instruments, documents, presentations, and interviews (see process 2.1, Examine Objective Evidence). Objective evidence is differentiated in terms of different types of PIIs (direct artifacts, indirect artifacts, and affirmations), as described in activity 1.4.3, Obtain Initial Objective Evidence. A combination of these indicator types is required for corroboration (see activity 2.2.1, Verify Objective Evidence). The data collection status is continually monitored during appraisal activities (see process 2.3, Document Objective Evidence) to ensure that sufficient data coverage is obtained. These are all key considerations that should be understood and accounted for in the generation of the data collection plan.

Multiple types of interviews can be used to obtain face-to-face affirmations (see activity 2.1.4, Examine Objective Evidence from Interviews):

- standard structured interviews scheduled in advance and using scripted questions
- on-call interviews, scheduled in advance for calendar purposes, but held only if it is determined they are necessary
- office hours interviews, for which interviewees are notified that they may need to be available as a contingency during scheduled periods

A robust data collection plan will plan for interviews of all three types. Start with a full set of scheduled interviews early in the planning phase, and gradually add/eliminate/modify events as the inventory of initial objective evidence indicates the need. The mini-teams may conduct office hours interviews, even during team training, to more fully populate the inventory of objective evidence prior to the start of the on-site data collection activities.

Planning for document reviews should include organizational-, project-, and implementation-level artifacts, as described in activity 2.1.3, Examine Objective Evidence from Documents.

Ultimately, the appraisal team will need to have data on each practice in the CMMI model, for each organizational element in the appraisal scope. For PAs addressing practices implemented at the project/program level (e.g., Project Planning), this means that data on each instantiation of the practice will be collected. For PAs addressing practices implemented at the organization level (e.g., Organizational Training), only one instantiation of each practice may be needed, depending on the way the organization chooses to implement such practices.

Continued on next page

1.5.2 Prepare Data Collection Plan (continued)

Implementation Guidance (continued)

The results of the analysis of initial objective evidence are used to determine which practices are not already covered with objective evidence. Practices for which no initial objective evidence has been provided should be identified as high-risk areas for the team to address immediately. The schedule for data collection may need to change dramatically if the team is unable to find relevant data for these areas in short order. In the case of practices for which data are available in the initial objective evidence, the team members assigned to the PAs plan the strategy for verifying the implementation of each of the practices through review of the named documents, interviews with the people who play the named roles, or other data collection events. Artifacts used to manage data collection events are populated with the current understanding of the planned data collection events, as follows:

- The schedule for interviews is finalized, so participants can be informed of the expectations for their participation as interviewees.
- The list of documents on hand (or accessible electronically) is finalized, so that the team members know what is and is not available for document review.
- A preliminary allocation of practices to be covered in each of the scheduled interviews is documented.
- A list of needed documents (not yet available to the team) is generated, if there are any known needs for documents at this point.



1.5.3 Replan Data Collection

Activity Description The data collection plan is updated as required during the conduct of the readiness review or during the appraisal itself as objective evidence is found, or as new sources of information are uncovered. The activity described in this section refers to a more substantial change in the plan, which is expected to be a rare occurrence in practice. If during the conduct of an appraisal, the team discovers that their assumptions about the availability of objective evidence are substantially incorrect, the appraisal team leader may renegotiate the appraisal plan with the sponsor.

- Required Practices**
- Review the current inventory of objective evidence and determine model practices for which the objective evidence is inadequate relative to the appraisal plan.
 - Revise the data collection plan as necessary based on the appraisal status and availability of objective evidence.
 - Renegotiate the appraisal plan with the sponsor if the appraisal cannot proceed as planned.
-

Parameters and Limits This activity is not a substitute for tactical decisions about where and how to find objective evidence. The intent of this activity is to respond to a major gap between expected data and actual data.

Major gaps between expected and actual data may occur, for example, as a result of the following:

- inaccurate assumptions about the availability of objective evidence
 - content of artifacts or information from interviews not providing significant amounts of the information required and other sources not being planned
 - unexpected absence of multiple key interviewees
 - unanticipated delays in the implementation of new processes
 - major customer-driven emergencies for one or more of the sampled projects
-

Continued on next page

1.5.3 Replan Data Collection (continued)

Optional Practices

Risk analysis can be conducted during early planning activities to establish thresholds and limits for the amount of missing objective evidence that will trigger this activity. This enables the appraisal team leader to state, in advance, the conditions under which the team and the sponsor must renegotiate the appraisal plan.

Contingency planning done in advance to identify ways of overcoming issues associated with missing objective evidence could include

- an alternate (fall-back) schedule for the appraisal
 - staffing to conduct a “crash data collection” activity
 - reducing the scope of the appraisal (e.g., appraising fewer PAs, limiting the extent of the organizational unit appraised)
-

Implementation Guidance

This activity serves as a “pressure valve” of sorts for the appraisal. The pressure to perform the appraisal under unrealistic conditions can lead to a severe degradation in the quality of the appraisal outputs. Carefully planning for contingencies and communicating them to the sponsor help to protect the standards that must be met in the performance of an appraisal. Clearly documenting the data collection plan, and regularly monitoring the availability of data compared to that plan, support effective risk mitigation.

When this activity must be employed to recover from an unrealistic expectation, the documentation reflecting the assumptions made during planning, as well as concrete facts about what is or is not available, are used to renegotiate with the appraisal sponsor. This is one of the reasons why a detailed appraisal plan, with the sponsor’s signature, is a required artifact for the conduct of a SCAMPI appraisal.



2.1 Examine Objective Evidence

Purpose	Collect information about the practices implemented in the organization and relate the resultant data to the reference model. Perform the activity in accordance with the data collection plan. Take corrective actions and revise the data collection plan as needed.
Entry Criteria	<ul style="list-style-type: none">• Data collection has been planned.• The sponsor has approved the appraisal plan.• The appraisal team is trained and is familiar with the appraisal plan.• Participants have been informed about the appraisal process and their roles in it.
Inputs	<ul style="list-style-type: none">• Appraisal data<ul style="list-style-type: none">- initial objective evidence- documents- documented practice implementation gaps, if any- feedback on preliminary findings (if that point in the timeline has been reached)• Data collection plan<ul style="list-style-type: none">- appraisal schedule- interview schedule- document list- new interview questions
Activities	<ul style="list-style-type: none">2.1.1 Examine Objective Evidence from Instruments2.1.2 Examine Objective Evidence from Presentations2.1.3 Examine Objective Evidence from Documents2.1.4 Examine Objective Evidence from Interviews
Outputs	<ul style="list-style-type: none">• Updated appraisal data• Updated data collection plan
Outcome	After the final iteration of this process, the team has sufficient data to create appraisal findings and to make judgments about the implementation of practices, as well as the satisfaction of specific and generic goals.
Exit Criteria	The coverage of the reference model and the organizational scope has been achieved, and the team is ready to produce the appraisal outputs.

Continued on next page

2.1 Examine Objective Evidence (continued)

Key Points	The efficient collection of objective evidence results from carefully creating and executing the data collection plan. Effective contingency planning and the use of work aids to monitor progress are key points to consider. The team must be able to focus on examining the most relevant information available, rather than be distracted by a mission to root out new evidence.
Tools and Techniques	Wall charts and other visual aids are often used to display the results of data collection activities. Electronic tools are prevalent among experienced Lead Appraisers, and can be very effective for continually monitoring and updating the inventory of objective evidence.
Metrics	Tracking the actual coverage obtained, as compared to the planned coverage, in each data collection activity facilitates timely corrective actions where they are needed. The most critical resource during an appraisal is time. Using a timekeeper during data collection and verification activities provides feedback on team performance. Recording the actual duration of planned events helps the team in taking actions to recover from unexpected events.
Verification and Validation	The appraisal method provides detailed verification and validation procedures for objective evidence. They are described in process 7, Verify and Validate Objective Evidence.
Records	Work aids used to record and track the progress of data collection activities are retained for traceability and provide an important input to a final report describing the appraisal, if the sponsor has requested a final report. The duration and effort required for specific data collection events can be recorded to provide useful historical data for planning subsequent appraisals.
Tailoring	The method is flexible in terms of the use of customized data collection instruments, presentations, document reviews, and interviews. Specialized forms of these data collection methods can be constructed to meet the objectives of the appraisal. For example, an organization-specific questionnaire could be used that contains local jargon rather than a standardized questionnaire. Standardized presentations can be employed to provide the team with an “inbrief” at the start of the appraisal. The method also provides flexibility in choosing the number, duration, style, and make-up of interview sessions within specified boundaries.

Continued on next page

2.1 Examine Objective Evidence (continued)

Interfaces with Other Processes

The activities that provide the team with data needed to produce reliable appraisal outputs are perhaps the most visible part of the appraisal process from the perspective of the appraised organization. For this reason, SCAMPI places a heavy emphasis on methodically planning and tracking the data collected during an appraisal. The initial objective evidence collected early in the process allows team members to analyze the state of information available at the earliest stages of the appraisal and narrow their search for new information. This early work serves to facilitate an efficient use of time. An explicit understanding of what information is needed and how that information will be used therefore drives the activities associated with this process.

Summary of Activities

The members of the team continually manage the data collected previously and target new data collection activities to fill known information needs. Instruments tend to be used early in the appraisal process, and often provide leads to be pursued through other data collection activities, in addition to affirmations of implemented practices. Presentations are sometimes used to provide a flexible forum where members of the organization can explain important information about the practices implemented in the organization. Documents provide the most explicit and lasting representation of practice implementation in the organization, and the team uses them to understand how practices in the CMMI model are implemented. Finally, interviews are used as the most dynamic data collection technique, allowing for branching among related topics and the explanation of contextual information that affects the implementation of practices as well as alternative practices.

The appraisal activities conducted for each of these data collection sources are similar:

- Determine if the information obtained is acceptable as objective evidence.
 - Relate the objective evidence to corresponding practices in the appraisal reference model.
 - Relate the objective evidence to the appropriate part of the appraised organizational unit (i.e., the instantiation).
-



2.1.1 Examine Objective Evidence from Instruments

Activity Description	<p>Instruments provided by the organizational unit are reviewed to obtain objective evidence reflecting the organization's implementation of model practices. Instruments include questionnaires, surveys, and other written information that indicates practice implementation.</p> <p>This activity builds upon the inventory of objective evidence that was developed during appraisal planning and preparation. The appraisal team considers the information contained in the instruments and determines if it is accurate, consistent, and relevant to the scope of the reference model being examined.</p> <p>Objective evidence obtained from instruments, and from other sources, is documented in process 2.3, Document Objective Evidence, and verified in process 2.2, Verify and Validate Objective Evidence.</p> <hr/>
Required Practices	<ul style="list-style-type: none">• Review information obtained from instruments and determine if it is acceptable as objective evidence.• Determine the model practices corresponding to the objective evidence obtained from instruments.• Determine the portions of the organizational unit that correspond to the objective evidence obtained from instruments. <hr/>
Parameters and Limits	<p>At least one instrument must be used during the conduct of the appraisal. (Refer to 1.4.2, Administer Instruments, for a description of instruments.)</p> <hr/>

Continued on next page

2.1.1 Examine Objective Evidence from Instruments (continued)

Optional Practices

Summaries of practice implementation data (collected via instruments) for a group of projects in an organization may be useful during the selection of the projects used to represent the organizational unit.

- The use of legacy processes (versus newly deployed processes) can be flagged using the responses to these instruments. This can support the inclusion or exclusion of projects using various versions of the organization's set of standard processes.
- This can also help flag situations where projects have not yet reached a particular point in the life cycle, allowing the appraisal team leader to avoid the anomalous situation where none of the sampled projects has yet reached the point where a practice under investigation has been implemented.

Create and administer a specialized questionnaire that is tailored to the characteristics of the organization, or the objectives of the appraisal.

Implementation Guidance

The use of instruments to gather written information from members of the organization provides a relatively low-cost data collection technique, when done well. Data of this type tend to be most useful when provided early in the appraisal conduct, and can lead to valuable insights about where data may be sought during subsequent data collection events.

The most common instrument used is the organization's PII database, which provides traceability of reference model practices to the processes and work products implemented within the organization. Where organizations have not yet implemented this asset, a questionnaire can be used to gather closed-ended responses and comments about the implementation of each model practice in each sampled project in the organizational unit.

It is also the responsibility of the appraisal team leader to prevent duplicate data entry on multiple instruments. No organization should be asked to provide the same information in two (or more) formats.



2.1.2 Examine Objective Evidence from Presentations

Activity Description Demonstrations of on-line tools, or libraries to be accessed by the appraisal team, are often the best way for members of the team to find the data and information they need. The history of process improvement in the organization or the status of current improvement projects can sometimes be best conveyed to the appraisal team in the form of a presentation. While the amount of data to be collected using presentations will be minimal, the ability to receive information and ask questions in real time makes this a valuable data collection technique.

Objective evidence obtained from presentations, and from other sources, is documented in process 2.3, Document Objective Evidence, and verified in process 2.2, Verify and Validate Objective Evidence.

- Required Practices**
- Receive presentations, if applicable, from the organizational unit.
 - Review information obtained from presentations and determine if it is acceptable as objective evidence.
 - Determine the model practices corresponding to the objective evidence obtained from presentations.
 - Determine the portions of the organizational unit that correspond to the objective evidence obtained from presentations.
-

Parameters and Limits There is no requirement for one or more presentations to be included in the data collection plan. The team must permit presentations of information by knowledgeable members of the organization. Presentations may or may not be “required” by the team, depending on the appraisal usage mode and the appraisal objectives.

It is not necessary that all team members be present at every presentation, though it may be advantageous. A minimum of two team members must be present in order to consider any presentation a valid data collection session.

Team members take notes during presentations to document information for later use, as described in activity 2.3.1, Take/Review/Tag Notes.

Continued on next page

2.1.2 Examine Objective Evidence from Presentations (continued)

Optional Practices Allow the organization to provide presentations or demonstrations of tools, as a means of providing objective evidence about the implementation of model practices.

Establish a standardized boilerplate for the organizational unit, or projects within the organizational unit, to use in orienting the appraisal team.

Implementation Guidance Presentations about the history of process improvement in an organization can be very revealing, and can help to shape the emphasis for further data collection.

Demonstrations of tools supporting the process infrastructure are sometimes the most convenient means of communicating objective evidence. Tools that are commonly demonstrated include

- requirements management and traceability tools
- configuration management library
- metrics database
- process asset library and tools
- process-related Web pages
- computer-based training courses or training repositories
- risk management databases

A configuration management library often embodies the process by which engineers manage configurations. These engineers may take for granted that certain standards are enforced through the tool and be unable to explain what those standards are in the abstract.

An organization's metrics database can often embody the analytical techniques in use, as well as the communication channels that are supported across the organizational unit.



2.1.3 Examine Objective Evidence from Documents

Activity Description A substantial portion of the data used by appraisal team members is derived from documents they review. Most of the direct artifacts used as indicators of practice implementation are documents. Document review is an effective means to gain detailed insight about the practices in use in the organization. However, without a clear focus on the data being sought, document review can consume a great deal of time as team members sometimes attempt to read everything in hopes that something useful will be discovered.

Objective evidence obtained from documents, and from other sources, is documented in process 2.3, Document Objective Evidence, and verified in process 2.2, Verify and Validate Objective Evidence.

- Required Practices**
- Establish and maintain a catalogue of documents used as a source of Objective Evidence.
 - Review information obtained from documents and determine if it is acceptable as objective evidence.
 - Determine the model practices corresponding to the objective evidence obtained from documents.
 - Determine the portions of the organizational unit that correspond to the objective evidence obtained from documents.
-

Parameters and Limits All SCAMPI appraisals must use documents as a source of information on the extent to which practices have been implemented in the organizational unit and within the sampled projects.

The catalogue should be sufficient to summarize the documentation objective evidence used as a basis for appraisal ratings generated, as required by the Appraisal Record described in activity 3.2.2, Generate Appraisal Record. Much of the catalogue contents can be obtained from the mapping data or instruments obtained from the organizational unit, such as the PII database, or questionnaires. The catalogue can be used to maintain a list of documents reviewed or additional documentation requested from the organizational unit.

Continued on next page

2.1.3 Examine Objective Evidence from Documents (continued)

Optional Practices For organizations with substantial intranets containing Web-based document libraries, a member of the organization familiar with the document library should provide a demonstration of the Web-based tools. Links to other documents and other features of the Web-based document library must be tested prior to the team's use during the appraisal.

Implementation Guidance One or more team members will seek data for every practice in the model scope of the appraisal through document review. This does not require a document for every practice, as any given document is likely to provide data relevant to multiple practices. To the greatest extent possible, the location of documented evidence relating to every practice should be recorded in advance of the team's arrival at the site where the appraisal will occur. Organizations with established improvement infrastructures typically maintain this type of information in order to track their improvement efforts against the model. Where this information is incomplete, the team will be forced to discover the linkages between the CMMI model and the organization's implemented practices, and will therefore require more time to perform the appraisal.

Implementation Guidance Documents reviewed during an appraisal can be classified into three different levels: organization, project, and implementation.

Three Levels of Documents By providing further insight into the policies and procedures that guide the organization's processes, organization-level documents sometimes help the team to eliminate the need for a question during an interview or sharpen the focus for a question. Review of these documents provides a context for understanding the expectations placed on projects within the organization.

Through the review of project-level documents, team members gain further insight into each scheduled interviewee's role in the project they support as well as the terminology generally accepted within the organization or project. This may lead to the refinement or modification of interview questions.

The team typically reviews implementation-level documents to validate information gathered from other sources, such as interviews or higher-level documents. Documents on this level provide an audit trail of the processes used and the work performed. The review of these documents frequently provides verification of practices found in organization- and project-level documents.



2.1.4 Examine Objective Evidence from Interviews

Activity Description

Interviews are used to obtain face-to-face affirmations relating to the implementation of processes at the organizational and project levels. Interviews are held with managers and practitioners responsible for the work being performed. The appraisal team uses interviews to understand how the processes are implemented and to probe areas where additional coverage of model practices is needed.

Interviews are a required and necessary component of a SCAMPI appraisal, in all usage modes. The criteria for the amount of face-to-face affirmation objective evidence that must be collected are described in activity 2.2.1, Verify Objective Evidence. This drives the development of the initial interviewing strategy in the data collection plan described in activity 1.5.2, Prepare Data Collection Plan. A variety of interviewing techniques are available, and the appraisal team leader works with the team to schedule the most appropriate interview types for the situation.

As objective evidence is gathered throughout the appraisal, the data collection plan is revised as necessary. By using focused investigation techniques, the need for interviews may be either increased or diminished, as long as the criteria for face-to-face affirmations are satisfied.

Objective evidence obtained from interviews, and from other sources, is documented in process 2.3, Document Objective Evidence, and verified in process 2.2, Verify and Validate Objective Evidence.

Required Practices

- Refine the data collection plan to determine the objective evidence that must be obtained from interview participants.
 - Review information obtained from interviews and determine if it is acceptable as objective evidence.
 - Determine the model practices corresponding to the objective evidence obtained from interviews.
 - Determine the portions of the organizational unit that correspond to the objective evidence obtained from interviews.
-

Continued on next page

2.1.4 Examine Objective Evidence from Interviews (continued)

Parameters and Limits

All SCAMPI appraisals must use interviews as a source of information on the extent to which practices have been implemented in the organizational unit and within the sampled projects.

All interviews must include at least two members of the appraisal team designated by the appraisal team leader.

Full coverage of the CMMI model, the organizational unit, and the organization's life cycle(s) must be achieved with the objective evidence considered by the team. Therefore the pool of potential interviewees must cover all elements of the process in use in the organizational unit.

Project and/or program management personnel are typically interviewed individually, or grouped according to project. The focus of the discussion in these interviews will therefore be scoped to a particular project, rather than across the sampled projects.

Functional Area Representatives (FARs) are typically interviewed in a group, sampling across the projects within the organizational unit. The focus of the discussion in these interviews will therefore be scoped to a particular set of practices, used across the projects.

The rules of confidentiality and the expected use of appraisal data must be communicated to every interviewee.

Optional Practices

Request that interviewees bring a document or other artifact with them to their interviews for a "show-and-tell" style interview.

Use video/teleconference technology to conduct interviews at a distance. Appraisers are cautioned not to rely too heavily on this method. If substantial portions of the interview data are gathered using this technology, it may tend to limit the amount of information collected.

Continued on next page

2.1.4 Examine Objective Evidence from Interviews (continued)

Implementation Guidance Interviews provide the most flexible source of detailed data. Face-to-face interaction with people who enact the practices being investigated allows the team to seek detailed information and to understand the interrelationships among various practices. Detailed information to address specific data collection needs can be sought and verified in real time.

It is important to avoid sampling interviewees for a session such that two people in the same reporting chain (e.g., a superior and one of his or her direct reports) are in the same interview session. This applies to members of the appraisal team as well. People who have this type of relationship with one another may be uncomfortable with the expectation for them to be completely candid during the interview.

Samples of interviewees are typically grouped into categories that roughly correspond to life-cycle phases, engineering disciplines, organizational groupings, and/or PA affinities. As stated previously, interviews of project/program management personnel are typically grouped by project, while FARs sampled for a given interview come from across the organizational unit.

There are three basic forms of interviews used in SCAMPI. They are described below.

Continued on next page

2.1.4 Examine Objective Evidence from Interviews (continued)

Implementation Guidance The most structured approach is the standard interview, which is scheduled in advance and employs a series of scripted questions. Each standard interview typically involves interviewees with similar responsibilities in the organization (e.g., Quality Assurance personnel, Systems Engineers, or Middle Managers). The schedule and location of each interview session is communicated to the interviewees well in advance. Questions intended to elicit data about particular practices are prepared and reviewed in advance, and the team follows a defined process for conducting the session. The entire team is present for these interviews. Responsibility for tracking the coverage of individual PAs is typically assigned to team members. A single questioner may lead the interview, with the rest of the team listening and taking notes, or the responsibility for asking questions may be distributed among the team members. In any case, it is expected that all team members who are not asking questions listen and take notes for all questions.

Standard Interviews

A set of planned interviews will be defined during appraisal planning. As the appraisal progresses and the objective evidence accumulates, the team may find it convenient to cancel one or more of these interviews to use the time for other activities. Such changes in the data collection plan are made in a way that does not violate the coverage criteria described in process 2.2, Verify and Validate Objective Evidence.

Implementation Guidance A more flexible approach to scheduling interviews is available in the form of on-call interviews, a variant of the standard interview. Prospective interviewees are identified and notified in advance, just as described above. However, the interviews are only held if team members decide that there is a need and that the time will be well spent. The prospective interviewees are therefore asked to block a period of time for such a contingency, and are informed the day before the scheduled time as to whether or not the interview session will actually happen. These interviews need not include the entire appraisal team, thus permitting parallel sessions with different interviewees. However, at least two members of the appraisal team (selected by the appraisal team leader) must participate.

On-Call Interviews

Continued on next page

2.1.4 Examine Objective Evidence from Interviews (continued)

Implementation Guidance Finally, office hours interviews represent an agreement for availability that permits pairs of team members to visit interviewees at their desks, cubicles, or offices. As with the on-call interviews, the prospective interviewees block a specific time period to be available on a contingency basis. It is expected that most prospective interviewees will be able to continue with their daily work and accommodate an interruption if the team needs to speak with them. Here again, only if specific data needs are identified will the interview occur. The interviewees should be informed that they may receive only limited advanced notice for these interviews, although confirming the interview at least a day in advance is a courtesy that should be offered whenever possible.



2.2 Verify and Validate Objective Evidence

Purpose	Verify the implementation of the organization's practices for each instantiation, and validate the preliminary findings, describing gaps in the implementation of model practices. Each implementation of each practice is verified so that it may be compared to the practices of the CMMI model, and the team characterizes the extent to which the practices in the model are implemented. Gaps in practice implementation are captured and validated with members of the organization. Exemplary implementations of model practices may be highlighted as strengths to be included in appraisal outputs.
Entry Criteria	Objective evidence has been collected about the implementation of practices in the organization. Gaps in the implementation of model practices have been identified, and the team is ready to characterize the extent to which model practices (or acceptable alternatives to those practices) have been implemented. Descriptions of practice implementation gaps at the level of the organizational unit have been crafted for validation.
Inputs	<ul style="list-style-type: none">• Appraisal plan, with schedule and participants for data validation activities• Data on practice implementation, and strength/weakness statements• Data collection plan, specifying any additional information needed
Activities	2.2.1 Verify Objective Evidence 2.2.2 Characterize Implementation of Model Practices 2.2.3 Validate Practice Implementation Gaps
Outputs	<ul style="list-style-type: none">• Updated appraisal data<ul style="list-style-type: none">- notes- strength/weakness statements- annotated worksheets• Updated appraisal artifacts<ul style="list-style-type: none">- preliminary findings- revised data collection plan- requests for additional data
Outcome	The team's confidence in the material that will form the basis for appraisal outputs is increased, and the process of transferring ownership of these results has been started. Any critical deficiencies in the data on hand have been identified and actions to resolve these issues have been initiated.
Exit Criteria	The team has recorded data on the implementation of practices in the organization, and characterized the extent to which practices in the model are implemented. In addition, strength and weakness statements have been validated with members of the organization who provided appraisal data.

Continued on next page

2.2 Verify and Validate Objective Evidence (continued)

Key Points	This activity spans a number of distinct events in the appraisal method that together accomplish the same goal—ensuring the validity of the appraisal data and associated outputs. Managing the interaction with people outside of the team is a vitally important process to ensure that the results will be accurate.
Tools and Techniques	Facilitation techniques to guide the team through difficult decisions are important during this activity (as they are during the Rating activity as well). Techniques to enhance the credibility of the preliminary findings are also important. Using a flip chart or note-taker during the presentation of preliminary findings is often effective for instilling confidence among audience members.
Metrics	Planned versus actual effort expended for this activity (as with all activities) will assist in monitoring progress as well as planning subsequent appraisals. Gauging the level of acceptance for preliminary findings can be facilitated by computing the percentage of findings adjusted based on feedback, then comparing this value with past experience.
Verification and Validation	The attendees of preliminary findings presentations are likely to express agreement and/or discuss issues with the data being validated. The appraisal team leader needs to ensure active participation in these activities as a way of verifying that the verification and validation process is working as intended. The actions taken following the appraisal will provide feedback to help validate that this activity was successful.
Records	Characterizations of practice implementation, strength/weakness statements and changes made based on feedback will be recorded for subsequent use by the team.
Tailoring	Validating data is required, but a variety of choices for orchestrating this process are available. The most common approach is the preliminary findings presentation. The use of an instrument or a more targeted focus-group approach to validate statements of practice implementation gaps is permitted. Also, the relative emphasis of mini-team-based verification and verification carried out by the team as a whole can be adjusted to meet the skills and preferences of the team at hand.

Continued on next page

2.2 Verify and Validate Objective Evidence (continued)

Interfaces with Other Processes

During the conduct of an appraisal, the team must gather and analyze a great deal of detailed information. Processes described earlier in this document clarify how data are gathered and examined. The process described here is focused on understanding the information revealed by the data. The processes described after this one are focused on carefully recording important information and making reliable and valid rating judgments based on the verified and validated data.

Summary of Activities

The initial objective evidence provided by the organization is used to understand how practices are intended to be implemented. Members of the appraisal team then seek information to confirm that the intended practices are indeed implemented. This first validation activity (2.2.1) may reveal gaps in the actual implementation that are not apparent in the initial objective evidence provided by the organization. The next verification activity (2.2.2) then compares the implemented practices to the practices in the CMMI model. This activity may also reveal gaps in the implementation(s) that will later bear on the ratings assigned by the team. Standard characterizations to capture the extent of practice implementation, first at the project level and then at the organizational unit level, are recorded by the team, along with descriptions of gaps in implementation. When team members have achieved their planned coverage of data collection, the descriptions of gaps are validated with the members of the organization. This final activity prior to rating allows team members to build confidence that their investigation has been thorough, and the members of the organization are provided with an opportunity to correct any perceived errors in the appraisal data.



2.2.1 Verify Objective Evidence

Activity Description The appraisal team must establish a clear understanding of the practices implemented in the organization. Typically, the organization provides a set of objective evidence at the beginning of the appraisal process, and the team sets out to verify the instances where those practices are implemented. For practices reflecting project-level activities, the team must observe that each selected project in the organizational unit has evidence of implementation. For practices reflecting organization-level activities, the team must understand the organization-level implementation as well as any activities involving the projects that indicate the implementation of the practice.

- Required Practices**
- Verify the appropriateness of direct artifacts provided by each instantiation for practices within the model scope of the appraisal.
 - Verify the appropriateness of indirect artifacts provided by each instantiation for practices within the model scope of the appraisal.
 - Verify the appropriateness of affirmations provided by each instantiation for practices within the model scope of the appraisal.
 - Verify that the implementation of each model practice is supported by direct artifacts for each instantiation, and corroborated by indirect artifacts or affirmations.
 - Obtain face-to-face affirmations for (1) at least one instantiation for each model practice in the scope of the appraisal, or (2) at least 50% of the practices corresponding to each specific and generic goal for each instantiation.
 - Generate statements describing gaps in the organizational unit's implemented practices relative to practices defined in the reference model.
-

Parameters and Limits For practices implemented at the project level, direct and indirect indicators of practice implementation must be examined for every project sampled to represent the organizational unit being appraised.

For practices implemented at the organization level, direct and indirect indicators of practice implementation are examined in reference to the organizational unit within the scope of the appraisal, and not necessarily for each project sampled. Aspects of the practice that are implemented at the project level must be investigated for every project sampled to represent the organizational unit.

One or more direct artifacts will be needed to verify implementation of each model practice. Indirect indicators can include either artifacts or affirmations. A description of these indicator types is contained in activity 1.4.3, Obtain Initial Objective Evidence.

Coverage criteria for face-to-face affirmations are focused at the goal and organizational unit level.

Continued on next page

2.2.1 Verify Objective Evidence (continued)

Optional Practices

At the discretion of the appraisal team leader, verification of practices at the instantiation level may be carried out solely by the mini-teams. Team-wide review and consensus on practice implementation can then focus on the aggregate-level characterizations.

At the discretion of the appraisal team leader, the verification of practice implementation at the project level can be reviewed for consensus by the entire team. Each mini-team provides an overview of practice implementation indicators for each project sampled to represent the organizational unit.

A mix of the two strategies above can be used, selectively reviewing targeted PAs in different ways, or gradually changing from one strategy to the other as the team gains familiarity with the data and the process.

Implementation Guidance

The typical work products listed in CMMI models provide examples of artifacts that can be used as indicators of practice implementation. However, the model does not distinguish between direct and indirect artifacts, and these are examples only and are not required; alternatives can be used for both direct and indirect artifacts.

Typically, much of the objective evidence required to perform this verification is provided in advance of the on-site period. The primary focus of data collection is to permit the team to verify that the intended practices are implemented across the organizational unit. Where the implemented practices differ from the intended practices, the objective evidence provided at the start of the appraisal process is annotated to more accurately reflect the implemented process in the organization. These annotations are typically statements describing a gap in the implementation of a model practice, some of which will eventually become findings.

Where gaps exist in the objective evidence provided in advance, the appraisal team is forced to undertake data collection activities to populate the data set from scratch. An organization that has a substantial process improvement infrastructure in place is expected to have documented its implementation of the model in detail. For organizations with relatively little experience using CMMI, the cost of this discovery process may be so great that undertaking an ARC Class A appraisal, such as SCAMPI, is not cost-effective. For such organizations, a Class B appraisal may be more appropriate.

Only after team members have a clear understanding of the implemented practices can they compare them to the model to characterize the extent to which the organization implements the practices in the model or acceptable alternatives. It is expected that artifacts that result from the performance of the practice will be available for viewing by the team. These artifacts, as well as face-to-face interactions with members of the organization enacting the practice, help to verify that the practice was enacted as the maintainers of the organizational process intended.



2.2.2 Characterize Implementation of Model Practices

Activity Description Once a critical mass of evidence on practice implementation has been verified, the team (or mini-team) turns to characterizing the implementation of model practices. For each practice in the model included in the selected scope, and each instance of expected use, the team will document a characterization of the extent to which the model practice (or an acceptable alternative) has been implemented. These project-level characterizations are then aggregated to the organizational unit level.

Characterizations of practice implementation are used as a means to focus appraisal team effort on areas where professional judgment is needed, and to aid in reaching team consensus on the extent to which practices are implemented.

- Required Practices**
- Characterize, for each instantiation, the extent to which reference model practices are implemented.
 - Aggregate practice implementation characterization values from the instantiation level to the organizational unit level.
-

Parameters and Limits The following table summarizes rules for characterizing instantiation-level implementations of practices. Consensus of at least a subset of appraisal team members (e.g., mini-team members) is necessary for instantiation-level characterizations.

Label	Meaning
Fully Implemented (FI)	<ul style="list-style-type: none">• The direct artifact is present and judged to be appropriate.• At least one indirect artifact and/or affirmation exists to confirm the implementation.• No substantial weaknesses were noted.
Largely Implemented (LI)	<ul style="list-style-type: none">• The direct artifact is present and judged to be appropriate.• At least one indirect artifact and/or affirmation exists to confirm the implementation.• One or more weaknesses were noted.
Partially Implemented (PI)	<ul style="list-style-type: none">• The direct artifact is absent or judged to be inadequate.• Artifacts or affirmations suggest that some aspects of the practice are implemented.• Weaknesses have been documented.
Not Implemented (NI)	<ul style="list-style-type: none">• Any situation not covered above

Continued on next page

2.2.2 Characterize Implementation of Model Practices (continued)

Parameters and Limits (continued)

The following table summarizes rules for aggregating instantiation-level characterizations to derive organizational unit-level characterizations. Consensus of all members of the appraisal team is necessary for organizational unit-level characterizations.

The column labeled “Condition” is the input condition—the practice implementation characterizations for the set of sampled projects. The column labeled “Outcome” is the resultant aggregated practice implementation characterization at the organizational unit level.

Condition	Outcome	Remarks
All X (e.g., all LI)	X	All instantiations have the same characterization.
All (LI or FI)	LI	All instantiations are characterized LI or higher.
Any PI, No NI	LI or PI	Team judgment is applied to choose LI or PI for the organizational unit.
Any NI	NI, PI, or LI	Team judgment is applied to choose NI, PI, or LI for the organizational unit.

Optional Practices

While the initial characterization of practice implementation may be proposed by a mini-team or some subset of the team, the following selections are available:

- Instantiation-level characterization of practice implementation can be reviewed by the entire team for consensus.
 - Team-wide review and consensus on practice implementation characterization can be reserved for the organizational unit level.
 - A mix of the two strategies above, tailored to match the learning curve of the team members or to reflect the prioritization of particular PAs, can be used.
-

Implementation Guidance

When the team is ready to perform the ratings, these characterizations serve to simplify the judgments. The team is then able to focus on the aggregation of weaknesses observed to determine the goal satisfaction ratings (explained in process 2.4). Situations where the project has not yet reached the appropriate point in time where the practice would be enacted are omitted from this characterization. The appraisal-planning activities are expected to prevent situations that severely limit the examples of actual implementation for any given practice.

Continued on next page

2.2.2 Characterize Implementation of Model Practices (continued)

Implementation Guidance (continued) The characterization of CMMI practice implementation begins as soon as sufficient data are available. It is not necessary that data for every instantiation be available before the implementation of any given practice can be characterized at the instantiation level. However, before the implementation of a practice across the organizational unit can be characterized, the instantiation-level characterizations must be completed. Each instance of practice enactment is characterized using the instantiation-level characterization scheme.

The characterization of practice implementation for the organizational unit is carried out using the aggregation rules summarized in the table above. These rules provide a basis for identifying the areas where professional judgment is required, and simplify the areas where the data are unanimous.



2.2.3 Validate Practice Implementation Gaps

Activity Description Verification activities lead to statements summarizing gaps (weaknesses) in the implementation of model practices. Optionally, statements reflecting exceptional implementations of model practices (strengths) may also be generated. These statements can be generated at various points in the appraisal process, such as when

- initial objective evidence is obtained,
- implemented practices are compared to the practices in the reference model,
- the extent of implementation is characterized for each project, or
- the extent of implementation is characterized for the organizational unit.

In preparation for validating this information, the appraisal team generates preliminary findings that summarize the practice implementation gaps. The preliminary findings are written in reference to a single model practice, and are abstracted to the level of the organizational unit. The statements should not reference a specific individual, project, or other identifiable organizational sub-unit.

This is still primarily a data collection activity, and the intent is to validate the appraisal team's understanding of the processes implemented within the organizational unit. Feedback from participants may result in modifications to the appraisal team's inventory of objective evidence. The results of the validation activity must be considered in the formulation of final findings and goal ratings. These latter activities cannot commence until after the validation activity has occurred.

Required Practices

- Generate preliminary findings summarizing gaps in practice implementation observed with the organizational unit relative to reference model practices.
 - Validate preliminary findings with members of the organizational unit.
-

Continued on next page

2.2.3 Validate Practice Implementation Gaps (continued)

**Parameters
and Limits**

Full appraisal team consensus must be reached on the preliminary findings prior to providing them to the organizational unit for validation.

Preliminary findings must be corroborated via multiple practice implementation indicator types (direct, indirect, affirmation). Areas where the appraisal team's inventory of objective evidence is insufficient to satisfy these criteria may instead be addressed by requests for additional information needed.

Preliminary findings must not refer to specific individuals, projects, or organizational sub-units.

Every model practice characterized as either Not Implemented or Partially Implemented, at the organizational unit level, must have at least one preliminary finding associated with it.

At least one representative from each project and from any associated staff functions must participate in the set of validation activities.

Only appraisal participants may participate (i.e., only people who provided data may participate in validation).

The minimum number of validation sessions required is one, and no more than five are recommended, although no maximum limit is specified.

The rules of confidentiality and the expected use of appraisal data must be communicated to participants in each validation activity.

Continued on next page

2.2.3 Validate Practice Implementation Gaps (continued)

Optional Practices

Preliminary findings (and other appraisal results) focused on specific projects, divisions, or other organizational sub-units may be generated if they are reflected in the appraisal objectives and constraints. This tailoring option also requires that the members of the organization participating in the appraisal be fully informed of the intended use of the information they provide to the appraisal team.

Implementation Guidance

Preliminary findings are the building blocks that lead to the judgment of goal satisfaction, and are the detailed information that forms the basis for the final findings. As an intermediate artifact of the appraisal process, preliminary findings are used to ensure traceability between appraisal inputs and appraisal outputs.

Feedback from participants on the preliminary findings should be solicited by the appraisal team and considered for possible revisions to its inventory of objective evidence.

It is not expected that preliminary findings will provide a detailed listing of the implementation status of every model practice in every sampled project. Furthermore, it is not expected that the preliminary findings will identify the status of individual projects with regard to practice implementation or goal achievement. An appraisal sponsor may request these more detailed appraisal results. The appraisal team leader should negotiate for the proper allocation of time to accommodate this tailoring option, and the expectation that such information will be preserved at the end of the appraisal should be made clear to all appraisal participants.

Continued on next page

2.2.3 Validate Practice Implementation Gaps (continued)

Implementation Guidance An interactive presentation is the most effective mechanism for validating the preliminary findings. The members of the organization who provided data to the appraisal team are typically brought together in a conference room, and a slide presentation is used to review the preliminary findings in an effort to invite people to provide additional data, or express their agreement with the summary statements. The audience is often grouped by seniority in the organization, and separate presentations are made for practitioners, project managers, and middle managers.

Preliminary Findings Presentations

During the presentation, one or more members of the team review the preliminary findings statements and provide the audience with an opportunity to comment or ask questions. The presenter uses only the words crafted by the appraisal team and avoids elaborating on the findings using his or her own words. When questions are asked about a preliminary finding, the team leader provides any clarification needed to understand what the statement means. However, team members avoid the appearance that they are justifying the content of the statement.

The detailed data that led to the preliminary findings must be protected, and there is no negotiation for wording or eliminating findings. The appraisal team must record new data made available to them without commenting on how the data may be interpreted or how the findings may need to change.

Implementation Guidance As an alternative (or in addition) to the presentation, focus groups can be used to probe more deeply into specific areas of the CMMI model with a targeted audience. This would permit the team to explore a particular area in more depth to help sharpen the appraisal results, or to raise the visibility of the results to people who are most informed on the topic. For example, a focus group conducted with project managers could be an ideal environment to validate (and gather more detailed data on) the topic of project planning and project monitoring. In contrast, a focus group composed of Engineering Process Group (EPG) members may be an ideal setting to validate findings associated with the organization's infrastructure for process improvement. The preliminary findings that relate to the group may be distributed as handouts or displayed using a projector, and the participants can engage in a free-form dialogue with the team and amongst themselves. Notes taken by the members of the team are treated as any data collected during an interview would be.

Focus Groups

Implementation Guidance Finally, a survey instrument can be used in addition (or as an alternative) to either of the techniques above. A carefully worded instrument that asks respondents to rate their level of agreement with the finding statement, and provides an opportunity for written feedback, can provide a low-cost and timely source of data for the team.

Survey Instrument



2.3 Document Objective Evidence

Purpose	Create lasting records of the information gathered by identifying and then consolidating notes, transforming the data into records that document practice implementation as well as strengths and weaknesses.
Entry Criteria	Planning activities for the appraisal are complete, including the selection and preparation of the appraisal team. At least one data collection activity has been conducted, and appraisal-relevant data are available to record.
Inputs	Appraisal data <ul style="list-style-type: none">• notes taken during data collection activities (if applicable)• annotated worksheets or other work aids containing data (if applicable)• strengths and weaknesses documented from previous activities• data collection plan
Activities	2.3.1. Take/Review/Tag Notes 2.3.2. Record Presence/Absence of Objective Evidence 2.3.3. Document Practice Implementation Gaps 2.3.4. Review and Update the Data Collection Plan
Outputs	<ul style="list-style-type: none">• Updated appraisal data<ul style="list-style-type: none">- noted practice implementation gaps (if any)- revised data collection plan (if applicable)- annotated worksheets• Requests for additional data (interviewees or documents)
Outcome	Individual team members understand the data collected thus far, and have information to guide any needed subsequent data collection.
Exit Criteria	All data from the most recent data collection session has been captured as a new baseline of practice implementation evidence or strength and weakness statements. The data-gathering plans have been updated to reflect additional information needed and topics that can be removed from active investigation.

Continued on next page

2.3 Document Objective Evidence (continued)

Key Points	This process has traditionally been the most difficult one to manage during an appraisal. Members of the team will tend to vary a great deal in their productivity and style of work. The team leader must be very attentive to the progress of each team member, and take effective corrective actions to ensure team progress.
Tools and Techniques	<p>Because of the challenging nature of this activity, Lead Appraisers tend to have strong preferences for tools and techniques they have found to be successful. Only a high-level list of tools and techniques is provided here.</p> <ul style="list-style-type: none">• Work aids like wall charts, spreadsheet programs, and automated database tools are frequently used to help track the status of data collection.• Using mini-teams, where pairs (or triplets) of team members are assigned specific PAs, is a very common practice.• Time management is a critical skill for this activity. Explicitly reviewing the effort spent, in real time, is a useful way to focus the team.• A variety of techniques for structuring team notebooks and formats for recording notes has been used.• Team norms regarding techniques for managing debates and divergent views are important, and should be made explicit well in advance.
Metrics	As mentioned above, tracking the effort expended during this activity (in real time) is a valuable technique to manage the team's time. The ability to quickly learn the rate at which each team member works is a skill that experienced Lead Appraisers develop using effort and duration metrics.
Verification and Validation	The method rules for recording traceability and validating data provide a lot in the way of verification and validation of the appraisal data. The role of the appraisal team leader in monitoring progress and the consensus decision-making process also serve as important verification and validation activities.
Records	All appraisal data are recorded with full traceability to information sources as well as the model components to which they pertain. The full detail in this traceability contains sensitive information that should not be provided to people outside of the appraisal team. The attribution of data to individuals or groups must never be divulged even if some of the detailed data are provided to the Engineering Process Group at a site for use in process improvement.
Tailoring	The use of a specialized appraisal data management tool is a common tailoring applied to this activity.

Continued on next page

2.3 Document Objective Evidence (continued)

Interfaces with Other Processes

The mechanics associated with the recording and transcription of objective evidence are described in this section. There are many links between these mechanics and the data collection process, as well as the data verification and validation process. It is important to understand that the data-recording process must support these other processes, and that the tools used during an appraisal will need to accommodate these linkages. Typically, an integrated database tool is used to manage all appraisal data that results from the analysis of notes taken during data collection.

Summary of Activities

The most basic representation of appraisal data is found in the notes taken by individual team members. These notes are reviewed and are typically “tagged” or otherwise processed before their information content is transformed into other lasting representations. The presence, absence, and/or appropriateness of objective evidence is then judged and recorded based on the data collected. The scheme by which this set of records is produced is an important implementation choice made by the appraisal team leader, and must be well understood by the team. Gaps in the implemented practices are also recorded, in a consistent manner that ensures traceability. Finally, the data collection plan must be reviewed in light of the changes in the set of data available to the team, and the remaining data needed to support reliable rating judgments.



2.3.1 Take/Review/Tag Notes

Activity Description As team members examine data sources, they will document *what* the objective evidence is (referencing documents, presentations, instruments, and interviewee comments), as well as *why* or *how* the objective evidence meets the intent of the model practice.

There may be special cases where team members elect to record data directly in the objective evidence tracking tool. In such cases the team members may choose not to take notes (on paper or in their notebooks) that describe the objective evidence.

For all interviews and presentations, the team members *must* take notes that capture the objective evidence before they move to the annotation of the objective evidence tracking tool.

Required Practices

- Record notes obtained from objective evidence data-gathering sessions.
- Relate notes to corresponding practices in the appraisal reference model.

Parameters and Limits Every team member present must take notes during interviews and presentations. These notes must cover all areas investigated during the interview, and are not limited to the PAs assigned to the individual team member (i.e., everybody takes notes on everything).

During document reviews and the review of instruments, notes must be taken to preserve specific context or focused references, if the rationale for accepting the objective evidence is not self-evident.

Whenever notes are taken in a data-gathering session, individual team members should review their notes immediately after the conclusion of the session. The review will focus on tagging significant items that relate to one or more model practice(s). This review and tagging process must occur within 24 hours of the data-gathering session.

Optional Practices Tagging schemes (that show traceability to model practices) and techniques for highlighting phrases are determined by the preferences of the note taker. A variety of formats for team member notebooks has been devised to facilitate note taking and tracking raw data during appraisals. Frequently, the questions used during an interview will be printed and collated within a team member notebook that contains note-taking forms and other useful information like interview schedules and document lists.

Notes can be recorded for items that have significant positive or negative impact upon the enactment of processes within the organizational unit, even if they are not directly related to model practices. These may ultimately be reflected in non-model findings reported to the organizational unit.

Continued on next page

2.3.1 Take/Review/Tag Notes (continued)

Implementation Guidance The raw notes taken during an appraisal are treated as confidential information, and may not be provided to any person outside of the appraisal team. Team members are typically required to destroy their notes in a secure manner at the conclusion of the appraisal. This ensures that the attribution of detailed information to individuals in the organization cannot lead to inappropriate consequences following the appraisal.

Implementation Guidance Team members actively take notes during all data-gathering sessions. The purpose is to record, verbatim, what the information source reveals about the implementation of practices in the project or organization. Note-taking is done for all types of objective evidence:

Taking Notes

- The analysis of instruments yields information and references regarding the implementation of practices, ideally with traceability to the model.
 - While reviewing documents it is often important to note a specific phrase or reference and to record the document name and page number.
 - When receiving presentations, phrases or references provided as elaboration on presentation material are captured in notes.
 - Interviews are the most intensive activity with regard to note taking. The purpose is to record what the interviewees said; not what the team member believes they meant.
-

Implementation Guidance The context in which the data are provided—be it during an interview, presentation, or in a document—bears on the proper interpretation of the facts. For example, notes taken during an interview are based on a give and take between the interviewer and the interviewee. The threads of discussion often provide a context that may not be reflected in a single excerpt from the middle of the interview. Note-takers should review their work to ensure that such contextual information can be preserved at least in their recollection, and preferably through the annotation of the notes.

Reviewing Notes

Implementation Guidance As notes are reviewed, team members often use highlighter pens or annotation schemes to identify the most salient excerpts. The PA and/or practice to which the information applies may be written in colored ink over the raw notes. All notes should identify the data-gathering session, and the pages should be numbered to preserve the sequence of information. For notes taken during interviews, it is often very useful to draw a seating chart to show where each person was sitting during the interview. Scripts prepared in advance of scheduled interviews may already be tagged, and can help relate responses to appropriate sections of the reference model. Some interviewee responses may deal with model practices other than those targeted by a given question, which would still necessitate some additional tagging.

Tagging Notes



2.3.2 Record Presence/Absence of Objective Evidence

Activity Description	The presence or absence of appropriate objective evidence for each model practice in the scope of the appraisal is determined based on information obtained from data-gathering sessions. Annotations are recorded indicating the source, relevance, and coverage of objective evidence collected. In situations where just referencing the data source would not make it obvious <i>why</i> the objective evidence is appropriate, a comment can be added to the annotation. For example, when an alternative to the typical work breakdown structure is used, it may be necessary to document why that alternative meets the intent of the model practice. Adding comments to the annotations can help to avoid rehashing the rationale for accepting the objective evidence multiple times during team discussions.
Required Practices	Record the presence or absence of appropriate objective evidence collected for each reference model practice.
Parameters and Limits	The inventory of objective evidence (be it in electronic or paper form) is updated to reflect what the data imply about the implementation of particular practices. For every practice within the model scope of the appraisal, annotations indicating the presence or absence of objective evidence will be made throughout the appraisal conduct. The annotation scheme used must ensure that the record reveals the following information: <ul style="list-style-type: none">• the project or organizational unit to which the data apply• the specific or generic practice to which the data apply• the type of objective evidence being recorded (i.e., direct, indirect, or affirmation)• whether the data imply the presence or absence of the objective evidence• whether the data suggest that the objective evidence is appropriate• comments about the appropriateness of the evidence (if needed)• whether or not additional information is needed before the team can characterize the extent to which the practice is implemented• a description of what the evidence is, if such a description was not provided by the organization in advance

Continued on next page

2.3.2 Record Presence/Absence of Objective Evidence (continued)

Optional Practices

Following each verification session where the presence or absence of objective evidence is recorded, the team reviews the judgments about each new piece of objective evidence. This may be useful in establishing a common understanding of the expectations for objective evidence, especially early in the appraisal.

Implementation Guidance

This activity represents the mechanical aspects of processing appraisal data, and is strongly tied to the activities described in process 2.2, Verify and Validate Objective Evidence. The emphasis of this activity description is on the steps needed to update the inventory of objective evidence and maintain traceability to data sources. The emphasis of the activity description in Verify and Validate Objective Evidence is on the interpretation of data collected and the sufficiency of objective evidence relative to the appraisal reference model.

Team members typically record the presence or absence of appropriate objective evidence into tools such as tracking tables or data consolidation worksheets. Prior to the assignment of goal ratings, the entire team reviews the status of the objective evidence as reflected in the annotations made by each team member.

The data gathered during every data collection session should be related to the practices in use in a project or across the organization. In recording the presence or absence of objective evidence, the intent is to quickly inventory the composite of factual information. Elaboration about what the data mean or how they relate to other important issues is captured either in notes or in the descriptions of practice implementation gaps crafted by team members.



2.3.3 Document Practice Implementation Gaps

Activity Description The primary intent of this activity is to derive, from the objective evidence gathered, summary prose statements that describe the gap between what the objective evidence shows and what the team was looking for to support a claim that the model practice was implemented. The statements explain why the practice is not considered to be Fully Implemented. Statements of practice implementation gaps will be validated with the organizational unit at a later time.

Strengths are not recorded pro forma when practices are found to be Fully Implemented. Where practices represent exemplary implementations of the model practices, the appraisal team will highlight these as part of the appraisal output. However, the primary focus of this benchmarking method is to help the organization verify the implementation of the model and identify areas where work is needed.

Required Practices Describe in writing gaps in the organizational unit's implemented processes relative to reference model practices.

Parameters and Limits For any practice that is characterized as something other than Fully Implemented, there must be a prose statement explaining the gap between what the organization does and what the model expects.

Regardless of the medium used, statements describing practice implementation gaps should be annotated with the following identifying information:

- the model component to which the statement relates (i.e., PA, goal, and practice)
- the data collection session(s) in which the information was uncovered
- the process instantiation(s) to which the statement applies

Prose statements of practice implementation gaps presented to the organizational unit in the form of preliminary findings for validation must be free of references to specific individuals or projects.

Continued on next page

2.3.3 Document Practice Implementation Gaps (continued)

Optional Practices

Document strengths in the implementation of model practices when the team discovers exemplary implementations.

Label implementation gaps as “opportunities for improvement” to avoid the potentially negative connotations of labeling them as weaknesses.

Document any significant issues impeding performance in the organization that do not necessarily map to the CMMI model. This must be done cautiously, and the number of these issues should not be larger than the number of model-related issues reported by the team.

Implementation Guidance

The database used to record the inventory of objective evidence may incorporate functionality to record practice implementation gaps and strengths, or a separate location or tool may be used if desired. Gaps in practice implementation should be recorded at the level of a particular instance of a model practice. These precursors to preliminary findings are more detailed and pointed, while all information presented outside of the team will be aggregated to the goal and organizational unit level of abstraction.

Strengths are only documented if the implementation of a practice is exceptional, and reflects a strong asset in the process in use. An adequate implementation of a model practice is not necessarily a strength. Team members should use their collective experience and judgment to determine whether or not they have uncovered an exemplary practice (above and beyond the capability described in the model) to highlight in the appraisal output.

Gaps in practice implementation are documented if the objective evidence indicates a missing component in the process or an inappropriate practice, in light of the value the practice is expected to add to the achievement of the goal. That is, practices that fail to help the organization meet the CMMI goal to which they relate should have a gap documented that explains why the goal is not met.



2.3.4 Review and Update the Data Collection Plan

Activity Description	This activity is used to continuously monitor the state of available objective evidence and to select the next tactic in the pursuit of obtaining full coverage of the model and the organizational unit.
Required Practices	<ul style="list-style-type: none">• Review the inventory of objective evidence collected and the data collection plan to determine what additional objective evidence is still needed for sufficient coverage of the model scope.• Revise the data collection plan to obtain additional objective evidence for instances where insufficient data are available to judge the implementation of reference model practices.• Identify priorities for the upcoming data collection events, and reevaluate the feasibility of the schedule in light of the current state of the objective evidence.
Parameters and Limits	This activity must be enacted at least once a day, and a consolidated summary of the appraisal data collection status must be available to the team at the start of each day during which data collection events are planned.
Optional Practices	In addition to the daily status mentioned above, more frequent status checks may be conducted. These interim status checks are not aggregated across the team, for a team-wide view of status, unless the appraisal team leader finds that beneficial.
Implementation Guidance	<p>The data collection status summarizes the differences between the objective evidence on hand and the evidence needed to support the creation of appraisal outputs (e.g., ratings). Annotations regarding the presence (and appropriateness) of objective evidence allow the team to inventory the state of the “knowledge base.” This status then drives requirements for the collection of more data, which must be met by the data collection plan. The annotation of the inventory of objective evidence is described in process 2.2, Verify and Validate Objective Evidence.</p> <p>The plan for future data collection should be revisited and updated as necessary. There may be several situations in which additional data are required for the team to sufficiently characterize the implementation of reference model practices. The following are examples of such situations:</p> <ul style="list-style-type: none">• The process of reconciling new data with old may identify conflicts or ambiguities in the data that require clarification.• The search for objective evidence may lead to the discovery of one or more previously undocumented practice(s) in the organization.• Attempts to confirm the use of a particular practice or tool in a project may have been unsuccessful.

Continued on next page

2.3.4 Review and Update the Data Collection Plan (continued)

Implementation Guidance (continued) Prioritizing data needs and allocating data collection effort to particular data collection events are ongoing activities that the appraisal team leader is responsible for overseeing. The data collection status summary may be performed by the appraisal team leader and reported to the team members, or the appraisal team leader may elect to have each mini-team perform this activity for the PAs it is assigned.

Specific information needed to resolve ambiguities or conflicts in the existing data should be documented for follow-up by one or more members of the team. For detailed data items that have a limited scope of impact, the notes of individual team members may be adequate to document the data needed. For example, whether or not a particular person is involved in a meeting, or reviews a given document, can be confirmed by a simple question asked during an on-call interview. Therefore, a note made by an individual team member to make sure the question is asked may suffice. In contrast, if conflicting information is uncovered about whether or not a given event occurred, like a meeting, more visibility of this conflict may be needed among the team members to understand why the information collected thus far is not internally consistent. In such a case, the person(s) responsible for the PA where that practice resides may need to alert the team to the conflicting data and facilitate a team discussion to seek clarity, as well as additional data. This may lead to the crafting of a specific interview question, which is used in a standard interview.

The data collection plan and inventory of objective evidence provide a means for the appraisal team to continuously monitor progress toward sufficient coverage of reference model practices in preparation for rating. Estimates of the additional data collection effort should be regularly reviewed. If the feasibility of the appraisal schedule is called into question, a replanning effort may be necessary (as described in activity 1.5.3, Replan Data Collection).



2.4 Generate Appraisal Results

Purpose	Rate goal satisfaction based upon the extent of practice implementation throughout the organizational unit. The extent of practice implementation is judged based on validated data (e.g., direct, indirect, and affirmation objective evidence) collected from the entire representative sample of the organizational unit. The rating of capability levels and/or maturity levels is driven by the goal satisfaction ratings.
Entry Criteria	The set of validated preliminary findings, statements of practice implementation gaps, and/or tabulations of validated objective evidence of practice implementation on which they are based are available. Team members are confident that they have obtained all the pertinent data they will need to make rating judgments. The data obtained completely covers the practices within the defined CMMI model scope and the entire representative sample selected for the organizational unit.
Inputs	Appraisal data <ul style="list-style-type: none">• validated preliminary findings• tabulations of objective evidence of practice implementation• annotated worksheets, checklists, working notes
Activities	2.4.1 Derive Findings and Rate Goals 2.4.2a Determine Process Area Capability Level 2.4.3a Determine Capability Profile 2.4.2b Determine Satisfaction of Process Areas 2.4.3b Determine Maturity Level 2.4.4 Document Appraisal Results
Outputs	<ul style="list-style-type: none">• Final findings• Recorded rating decisions
Outcome	A formal rating decision for each reference model component that was planned to be rated, and for which the team obtained complete or sufficient data
Exit Criteria	Ratings against all components per the plan have been made and recorded.

Continued on next page

2.4 Generate Appraisal Results (continued)

Key Points	<p>The judgment of goal satisfaction is based upon and traceable to the extent of the implementation of practices associated with that goal (or alternative practices contributing equivalently to goal satisfaction).</p> <p>Success in this activity is driven by team members' ability to limit their focus to the data that support the judgments, and to avoid issues that threaten their ability to be objective. This activity can create a great deal of stress for team members under pressure to help their organization "do well"; the team leader must skillfully facilitate this activity when external pressures exist.</p>
Tools and Techniques	<p>There is a significant amount of data to review in making each round of judgments. Rating worksheets and automated support tools facilitate the team's decision-making process by presenting necessary data in a concise, well-organized manner. When controversial issues are encountered, the team leader must actively facilitate to ensure that the team remains focused on the pertinent issues. Strategic rest breaks, and sequencing and pacing critical discussions, are often keys to success.</p>
Metrics	<ul style="list-style-type: none">• Planned versus actual effort for each component rated• Number of model components rated satisfied or unsatisfied
Verification and Validation	<p>The team leader verifies that the rating process was performed in accordance with the method rules and the rating baseline selected and documented in the appraisal plan. Work aids used to record the team judgments help ensure traceability to the basis for the rating judgments.</p>
Records	<p>A worksheet or other work aid may be used to make a record of the rating decisions. A Process Area Profile is often an effective means of recording and communicating these results.</p>
Tailoring	<p>The method provides tailoring options for rating additional model components. The minimum requirement is to rate the specific and generic goals associated with each PA in the scope of the appraisal. In addition, the sponsor may request that maturity level and/or capability level ratings be performed and reported. Through negotiation between the appraisal team leader and the appraisal sponsor, a decision to rate individual practices can also be made.</p>

Continued on next page

2.4 Generate Appraisal Results (continued)

Interfaces with Other Processes

The rating judgments made by the appraisal team members are dependent on the quality of the data available to them, as well as their ability to reliably judge the implementation and institutionalization of practices in the organization that relate to the CMMI model. All the processes previously described contribute to the team's ability to effectively execute this process. The Analyze Requirements process establishes the rating baseline, the organizational unit to which ratings will apply, and the purpose for which the ratings will be used. The Develop Appraisal Plan process, in conjunction with the Obtain and Analyze Initial Objective Evidence and Prepare for Collection of Objective Evidence processes, determine the sample of the organizational unit for which data will be collected and from which the ratings will be determined. The Select and Prepare Team process ensures that the team has sufficient knowledge and skills to interpret the data and arrive at sound rating judgments. The Examine Objective Evidence and Document Objective Evidence processes provide the basic information that is needed to support judgments in a form that facilitates making the judgments. The Verify and Validate Objective Evidence process characterizes the extent to which the organization implements practices in the model (or acceptable alternatives) and validates findings describing any weaknesses associated with the practice implementations. Upon the successful execution of these processes, the team is ready to rate the satisfaction of goals dependent on those practices.

Summary of Activities

The required and fundamental rating activity involves making team judgments about goal satisfaction for each and every specific and generic goal within the model scope defined in the rating baseline. Once goal satisfaction has been determined, optional rating activities can be performed in accordance with the defined rating baseline and the selected model representation(s) (continuous, staged, or both). The first optional activity focuses on rolling up goal satisfaction to PA ratings. The team determines a PA capability level rating (0 through 5) for each PA in the continuous representation that is within the appraisal scope, and/or the team determines a Satisfied/Unsatisfied rating for each PA in the staged representation that is within the appraisal scope. The second optional activity continues the rating roll up to cover all PAs within the selected model scope. In the case of the continuous representation the team creates a profile showing the capability levels for all PAs considered. The profile can then be used to compute a maturity level through the equivalent staging described in the model. In the case of the staged representation the team assigns a maturity level rating (1 through 5) corresponding to the highest level in the model for which all applicable PAs have been rated as satisfied. The optional activities described in 2.4.2a and 2.4.3a cover the continuous representation; those in 2.4.2b and 2.4.3b cover the staged representation. As indicated, these options are not mutually exclusive.



2.4.1 Derive Findings and Rate Goals

Activity Description The judgments made about goal satisfaction are driven by the findings that were documented by the appraisal team and validated by appraisal participants. The preliminary findings focus on gaps in the implementation of practices. When performing goal ratings, the team must judge whether or not these gaps in the implementation of practices (in aggregate) threaten the organization's ability to satisfy the goals associated with the practices.

Required Practices

- Derive final findings using preliminary findings statements, feedback from validation activities, and any additional objective evidence collected as a result of the validation activity.
- Rate each specific goal and generic goal within the reference model scope of the appraisal, based on the practice implementation characterizations at the organizational unit level, as well as the aggregation of weaknesses associated with that goal.
- Obtain appraisal team consensus on the practice implementation characterizations, findings statements, and ratings generated for the organizational unit level.

Parameters and Limits When deriving final findings, the aim is to create goal-level statements that summarize the gaps in practice implementation. These statements must be abstracted to the level of the organizational unit, and cannot focus on individual projects (unless the tailoring option for project-specific findings has been agreed upon during planning).

If there are no findings that document the weaknesses associated with a goal, the goal must be satisfied.

The goal is rated Satisfied if

- all associated practices are characterized at the organizational unit level as either Largely Implemented or Fully Implemented, and
- the aggregation of weaknesses associated with the goal does not have a significant negative impact on goal achievement.

For a goal to be rated as Unsatisfied, the team must be able to describe how the set of weaknesses (or single weakness) led to this rating.

Continued on next page

2.4.1 Derive Findings and Rate Goals (continued)

Optional Practices

Findings statements and satisfaction ratings may be specified at the level of individual practices if the appraisal sponsor specifically requests this tailoring option. These practice-level ratings must be based on the extent to which the implemented practice (or the absence of implementation) supports the achievement of the related goal. The use of informative material to form a checklist is explicitly discouraged. A rating algorithm for practices that does not have a demonstrable link to PA goals would depart from the intended use of CMMI components.

Implementation Guidance

Any endeavor that results in producing a score, grade, or rating is by definition an area of sensitivity to those affected by the outcome. An objective and clear-cut basis for assigning a rating lessens this sensitivity and results in a more consistent basis of comparison among the organizational units and goals rated. Judgments made prior to and during the rating process should be based on observable facts and should be made at the lowest level of abstraction that makes sense. In the case of CMMI, the lowest level of abstraction is characterizing the extent of practice implementation for each process instantiation within the representative sample. Characterizations made at the instantiation level are aggregated into a characterization of the extent of practice implementation throughout the organization, as described earlier in process 2.2, Verify and Validate Objective Evidence. The judgment of goal satisfaction is then based upon, and directly traceable to, the extent of implementation of practices associated with that goal (or alternative practices contributing equivalently to goal satisfaction).

Findings should be phrased in terms that best facilitate decision making by the appraisal sponsor and taking action upon the appraisal results.



2.4.2a Determine Process Area Capability Level

Activity Description When using the continuous representation of a CMMI model, the team may make rating judgments about each PA (and associated capability level) within the scope of the appraisal. Assigning capability level ratings is an optional activity, selected at the discretion of the appraisal sponsor and documented in the appraisal input.

Required Practices Rate the capability levels for each PA within the scope of the appraisal, based upon the highest level and all levels below for which its specific goals and the generic goals within the appraisal scope have been satisfied (if this rating option was selected during planning).

Parameters and Limits The table below provides the criteria for deriving the capability level rating for each PA.

Capability Level	Engineering Process Areas	Other Process Areas
0	Default Rating	Default Rating
1	Generic goal for capability level 1 is rated Satisfied. All specific goals are rated Satisfied – including base practices only.	Generic goal for capability level 1 is rated Satisfied. All specific goals are rated Satisfied.
2	Generic goals for capability levels 1 and 2 are rated Satisfied. All specific goals are rated Satisfied – including specific practices at capability levels 1 and 2.	Generic goals for capability levels 1 and 2 are rated Satisfied. All specific goals are rated Satisfied.
3	Generic goals for capability levels 1, 2, and 3 are rated Satisfied. All specific goals are rated Satisfied – including specific practices at capability levels 1, 2, and 3.	Generic goals for capability levels 1, 2, and 3 are rated Satisfied. All specific goals are rated Satisfied.
4	Generic goals for capability levels 1, 2, 3, and 4 are rated Satisfied. All specific goals are rated Satisfied – including specific practices at capability levels 1, 2, and 3.	Generic goals for capability levels 1, 2, 3, and 4 are rated Satisfied. All specific goals are rated Satisfied.
5	Generic goals for capability levels 1, 2, 3, 4, and 5 are rated Satisfied. All specific goals are rated Satisfied – including specific practices at capability levels 1, 2, and 3.	Generic goals for capability levels 1, 2, 3, 4, and 5 are rated Satisfied. All specific goals are rated Satisfied.

Continued on next page

2.4.2a Determine Process Area Capability Level (continued)

Optional Practices

The rating of PA capability levels may be carried out top down or bottom up, as described below.

The bottom up approach uses the following sequence:

- Judge whether or not the PA can be considered to be at capability level 1, based on the satisfaction of specific and generic goals. In this case, only the base practices would be considered in rating goals.
- Judge whether or not the PA can be considered to be at capability level 2, based on the satisfaction of specific and generic goals. In this case, the advanced practices for capability level 2 must be considered in rating the goals of the Engineering PAs.
- Proceed incrementally until the team reaches a point at which the goals cannot be rated as satisfied.

The top down approach uses the following sequence:

- Begin at the highest desired capability level (which was determined during appraisal planning) and judge whether or not the PA can be considered to be operating at that capability level.
 - If the PA is not at the highest desired capability level, consider whether or not it can be judged to be operating at the next lower level.
 - Proceed incrementally until the team reaches a point at which all of the relevant goals are rated as satisfied, or goal ratings lead to capability level 0.
-

Implementation Guidance

The presence of advanced practices in the Engineering PAs creates a nuance in the rating process that can be complicated for some appraisal team members. If team members have only worked with the staged representation in the past, it is important that the appraisal team leader covers this nuance during team training, and prevents confusion during the rating process.

Goal satisfaction is a judgment based on the implementation of practices that map to the goal. In rating the satisfaction of specific goals in the Engineering PAs, the set of specific practices that relates to the goals differs for capability levels 0, 1, 2, and 3 through 5. That is, depending on the capability level at which the rating is performed, there are up to 4 unique sets of specific practices associated with these specific goals that must be considered.

The appraisal team leader is responsible for selecting one of the two optional rating approaches described above, and should facilitate this session carefully to prevent confusion among team members.



2.4.2b Determine Satisfaction of Process Areas

Activity Description	When using the staged representation of a CMMI model, the team may derive the satisfaction of PAs from the set of goal satisfaction judgments. Assigning PA satisfaction ratings is an optional activity, selected at the discretion of the appraisal sponsor and documented in the appraisal input.
Required Practices	Rate the satisfaction of each PA in the scope of the appraisal based on the ratings of the goals within each PA, if this rating option was selected during planning.
Parameters and Limits	<p>PAs may be assigned rating values of Satisfied, Unsatisfied, Not Applicable, or Not Rated.</p> <p>A PA is rated Satisfied if and only if all of its specific goals and generic goals are rated Satisfied.</p> <p>If even one of the goals in a PA is rated Unsatisfied, then the PA is rated Unsatisfied.</p> <p>When a PA is determined to be outside of the organizational unit's scope of work, the PA is designated as Not Applicable and is not rated. The identification of a PA as Not Applicable must occur during the planning of the appraisal.</p> <p>When a PA is outside of the appraisal scope, or if the associated set of objective evidence does not meet the defined criteria for sufficient data coverage, the PA is designated as Not Rated and is not rated. The criteria for sufficient data coverage are described in activity 2.2.1, Verify Objective Evidence.</p>
Optional Practices	A profile to summarize the satisfaction of goals may be created to provide further insight about the rating outcomes. Where a PA is rated as Unsatisfied, this more detailed view of the rating outcomes may provide focus and visibility at a lower level of detail.
Implementation Guidance	<p>PA satisfaction is a direct function of goal satisfaction. A PA is rated as Satisfied if every goal contained in the PA is rated as Satisfied. A PA is rated as Unsatisfied if any goal is rated as Unsatisfied. This ensures that one or more weaknesses exist that serve to explain why the goal and therefore the PA are not satisfied.</p> <p>PA ratings need not be reported to appraisal participants, if the sponsor does not wish to disclose these results. However, a documented output from this rating activity, if it is performed, is a required component in the Appraisal Record.</p>



2.4.3a Determine Capability Profile

Activity Description	When using the continuous representation of a CMMI model, the team may determine a Capability Profile that graphically depicts the capability level ratings assigned to each PA within the scope of the appraisal. The generation of a Capability Profile is an optional activity, selected at the discretion of the appraisal sponsor and documented in the appraisal input.
Required Practices	Generate a Capability Profile depicting the capability level attained for each PA within the scope of the appraisal, if this rating option was selected during planning.
Parameters and Limits	<p>A simple bar chart is used for this display. Each PA is represented in a single bar along the horizontal axis, and the vertical axis represents the capability level dimension. The height of each bar communicates the capability level of the PA represented.</p> <p>Capability levels take only the values 0, 1, 2, 3, 4, or 5. Intermediate values (e.g., 2.7) are not defined for this appraisal outcome, and any embellishment of the Capability Profile with such values is outside the boundaries of SCAMPI.</p>
Optional Practices	<p>A profile to summarize the satisfaction of goals may be created to provide further insight about the rating outcomes. In situations where a PA capability level rating does not reflect the desired outcome, this more detailed view may provide focus and visibility at a lower level of detail.</p> <p>CMMI provides for equivalent staging, whereby a Capability Profile can be used to derive an equivalent maturity level rating (see activity 2.4.3b, Determine Maturity Level).</p>
Implementation Guidance	<p>A presentation template referred to as a Capability Profile is typically used to communicate the aggregate level rating results to the sponsor and others designated by the sponsor.</p> <p>Comparing different PAs with respect to their relative capability level ratings may be informative in discussing trends or patterns in the organization.</p> <p>This activity may be omitted entirely, as it is a tailoring option. If a Capability Profile is to be derived, the ratings reflected in the profile are derived as described in activity 2.4.2b, Determine Process Area Capability Level.</p>



2.4.3b Determine Maturity Level

Activity Description	Historically, one of the most visible outcomes of an appraisal has been the maturity level rating assigned. The determination of a maturity level rating is straightforward, and is derived mechanically from the ratings assigned at the lower levels of detail. Assigning a maturity level rating is an optional activity, selected at the discretion of the appraisal sponsor and documented in the appraisal input.
Required Practices	Rate the maturity level based on the ratings assigned to PAs, if this rating option was selected during planning.
Parameters and Limits	<p>The maturity level determined is the highest level at which all PAs contained within the maturity level, and within all lower maturity levels, are rated as Satisfied or Not Applicable. The single exception to this rule is that the maturity level 3 goal for each applicable maturity level 2 PA must also be rated Satisfied for a maturity level rating of 3 or higher to be determined.</p> <p>When using continuous representations, CMMI provides for equivalent staging, whereby a Capability Profile can be used to derive an equivalent maturity level rating. A maturity level for a continuous representation is achieved if the Capability Profile is at or above the target profile for all PAs for that maturity level and all lower maturity levels in the equivalent staging, excepting those PAs that are designated as Not Applicable. The equivalence of particular Capability Profiles and particular maturity levels is addressed in an appendix to the CMMI model.</p> <p>To determine a maturity level as an output of the appraisal, the model scope of the appraisal must include the minimum set of PAs required by the CMMI model. Please refer to the tailoring section of the CMMI model for guidelines on what the minimally acceptable scope of the model is for each maturity level.</p>
Optional Practices	None.
Implementation Guidance	This activity may be omitted entirely, as it is a tailoring option. If a maturity level is to be reported, the PA ratings that form the basis for the maturity level rating are derived as described in activity 2.4.2b, Determine Satisfaction of Process Areas.



2.4.4 Document Appraisal Results

Activity Description The results of the appraisal conduct must be documented for reporting. Verbal reports of the rating outcomes or face-to-face explanations of implementation gaps discovered by the team are not sufficient to communicate appraisal results.

Required Practices

- Document the final findings.
- Document the rating outcome(s).
- Document the Appraisal Disclosure Statement (ADS).

Parameters and Limits The ADS and the set of appraisal outputs agreed upon with the appraisal sponsor must be documented. These appraisal outputs may exclude all ratings, and the sponsor is free to select and disclose a variety of appraisal outcomes, as specified in the activities of this process.

Regardless of the needs of the sponsor, the ADS, the goal ratings, and the associated findings must be documented as a part of the appraisal information returned to the CMMI Steward.

Optional Practices Any optional outputs requested by the appraisal sponsor are also created during this activity.

Implementation Guidance This activity is focused on collecting and documenting the results of prior activities related to the generation of findings and ratings. Depending on the planned recipients of the results, multiple forms of the results may be needed. Certain data may not be appropriate for all audiences, or the style or language of the results may need to be adjusted to best fit the needs of the recipients.

The documented appraisal results are typically provided in a final findings presentation, described in activity 3.1.1, Present Final Findings.



3.1 Deliver Appraisal Results

Purpose	Provide credible appraisal results that can be used to guide actions. Represent the strengths and weaknesses of the processes in use at the time. Provide ratings (if planned for) that accurately reflect the capability level or maturity level of the processes in use.
Entry Criteria	<ul style="list-style-type: none">• Objective evidence has been validated (through the team process).• Preliminary findings have been validated.• Ratings have been determined (for model components selected for rating).• Final findings have been created and reviewed by the team.
Inputs	<ul style="list-style-type: none">• Appraisal data<ul style="list-style-type: none">- final findings- ratings• Appraisal artifacts<ul style="list-style-type: none">- appraisal input- appraisal plan
Activities	3.1.1 Present Final Findings 3.1.2 Conduct Executive Session(s) 3.1.3 Plan for Next Steps
Outputs	<ul style="list-style-type: none">• Documented final findings• Final report (if requested)• Recommendations report (if requested)
Outcome	<ul style="list-style-type: none">• The sponsor and the appraised organizational unit are provided with the results of the appraisal.• A valid and reliable characterization of the current state of the processes in use across the organizational unit is documented.
Exit Criteria	<ul style="list-style-type: none">• Appraisal results are delivered to the appraisal sponsor and organizational unit.• An executive session is conducted, if appropriate.

Continued on next page

3.1 Deliver Appraisal Results (continued)

Key Points	The appraisal results are intended to support decision making, and need to be delivered in a way that promotes appropriate actions. Whether the appraisal was conducted for internal process improvement, supplier selection, or process monitoring purposes, the delivery of results should facilitate the actions that will be driven by the information.
Tools and Techniques	Templates containing standard information for use in a final findings briefing are provided to all SCAMPI Lead Appraisers. Experienced appraisers frequently use electronic (database) tools that support the transformation of raw appraisal data into appraisal results. These tools may be useful in real time as appraisal results are presented. Strategies for presenting and packaging the results should leverage presentation and documentation techniques that best suit the audience.
Metrics	It is highly recommended that the attendance at the final briefing (if one is held) be recorded. Significant absenteeism of key stakeholders is likely to be an indication of risk for future success in addressing the appraisal findings.
Verification and Validation	The required elements of appraisal results are specified in the activity description found here, and a checklist can support verification that these elements are present. Validation of this activity can only occur after the appraisal is complete.
Records	<ul style="list-style-type: none">• Final findings• Final report (if requested)• Recommendations report (if requested)
Tailoring	<p>If the method is being used as part of a supplier selection process, there may be acquisition regulations or limitations that constrain the mechanisms used to deliver appraisal results to the appraised organization.</p> <p>In some internal process improvement usage of the method, the executive session may be tailored out. The appraisal sponsor should make this decision, with the full involvement of the appraisal team leader.</p>

Continued on next page

3.1 Deliver Appraisal Results (continued)

**Interfaces
with Other
Processes**

Upon completion of the Generate Appraisal Results process, the ratings and findings generated are used to prepare and deliver the final appraisal results to the appraisal sponsor and organizational unit. The appraisal results become part of the Appraisal Record, which is discussed in process 3.2, Package and Archive Appraisal Assets.

**Summary of
Activities**

The final findings contain the validated strengths, weaknesses, and ratings (as defined by the appraisal plan), reflecting the organizational process capability and/or maturity level for PAs within the appraisal scope. Other appraisal outputs, as requested by the appraisal sponsor and documented in the appraisal plan, are generated and provided. Optionally, a separate executive session may also be held to clarify and discuss the appraisal results from a senior management perspective that facilitates decision making. Plans are established for acting upon the appraisal results.



3.1.1 Present Final Findings

Activity Description

The final findings contain a summary of the strengths and weaknesses for each PA within the appraisal scope, as well as additional information that provides context for the findings. The generation of the findings is addressed in activity 2.4.1, Derive Findings and Rate Goals; this activity relates to the presentation of these findings to the appraisal sponsor and appraised organization. The presentation may be in a summarized form, with the detailed findings provided as backup information, and is often presented using view graphs in a meeting room or auditorium.

In addition to the final findings, a draft ADS summarizing the results of the appraisal is provided to the appraisal sponsor.

Required Practices

- Provide appraisal final findings to the appraisal sponsor and the organizational unit.
 - Provide an ADS to the appraisal sponsor summarizing the appraisal results and conditions under which the appraisal was performed.
-

Parameters and Limits

Required elements of the final findings include

- summary of the appraisal process
- findings (summary of strengths and weaknesses)

Appraisal team consensus must be obtained on the wording of the final findings, to ensure that the whole team supports the accuracy of the described appraisal results.

The team, when delivering the final findings, must adhere to some important principles:

- If a model component is reported as Unsatisfied, the corresponding findings of weaknesses that caused the team to make that judgment must also be reported.
- Confidentiality and non-attribution principles apply to statements made in the presentation of final findings.

The ADS is a summary statement describing the appraisal results that includes the conditions and constraints under which the appraisal was performed. It contains information considered essential to adequately interpret the meaning of assigned maturity level or capability level ratings. The ADS is prepared by the appraisal team leader and provided to the appraisal sponsor. Otherwise the appraisal team leader delivers the ADS to the sponsor as a separate document.

A detailed description of the ADS contents is provided in Appendix A. The ADS is considered a draft at this stage of the appraisal process, in that the ADS must also contain an affirmation that all appraisal requirements have been satisfied, which cannot be claimed until the completion of all appraisal activities.

Continued on next page

3.1.1 Present Final Findings (continued)

Optional Practices

Optional elements of the final findings include

- ratings
- improvement activities
- recommended actions
- schedule of major upcoming events (e.g., appraisal report, recommendations, action plan, reappraisal)

Note that the generation of goal ratings by the appraisal team is required (as described in process 2.4, Generate Appraisal Results). However, these ratings may be excluded from the final findings at the discretion of the appraisal sponsor.

A formal presentation of appraisal results, delivered by the appraisal team, is frequently the final visible activity for appraisals conducted for internal process improvement. The final findings presentation typically is delivered in the form of a face-to-face briefing at the end of the appraisal on-site period. Other mechanisms for providing the appraisal results to the organizational unit, such as written reports, may be more practical in supplier selection or process monitoring usage of the method. The timeframe in which the appraisal results are provided may also vary, but the appraisal cannot be considered complete until the final findings are provided.

The draft ADS may optionally be provided during the executive session(s), if performed, instead of at the conclusion of the final findings briefing.

Continued on next page

3.1.1 Present Final Findings (continued)

Implementation Guidance A template for a final findings briefing, describing its typical contents and format, is provided to Lead Appraisers as a work aid by the CMMI Steward.

Findings include a summary of strengths and weaknesses determined for each PA within the appraisal reference model scope. This may also include global findings that apply across multiple PAs, and non-reference model findings that affect the implementation (positively or negatively) of associated processes within the organizational unit.

Normally, the appraisal team leader presents the final findings. In some applications of the method for internal process improvement, the team may elect to have an appraisal team member from the organizational unit provide the briefing to encourage the acceptance of the final findings and ownership of the appraisal results for follow-on action.

As a courtesy, the appraisal team can consider informing the appraisal sponsor and/or the senior site manager of the appraisal results prior to presenting them publicly in the final findings briefing. This may help them to avoid surprises and obtain feedback on ways to present the findings that best meet the needs of the sponsor, appraisal participants, and the organizational unit. See activity 3.1.2, Conduct Executive Session(s) for a description of topics for discussion.

The number and scope of findings reported will affect the impact of appraisal results, whether or not the team intends for this to happen. There are times when providing a long list of details is beneficial. Other times, high-level summaries are more appropriate.



3.1.2 Conduct Executive Session(s)

Activity Description The executive session is an optional activity that may be performed at the discretion of the appraisal sponsor or senior site manager. The executive session provides the appraisal sponsor, senior site manager, and invited staff a private opportunity to (a) discuss with the appraisal team leader any issues with the appraisal, (b) obtain clarification of the appraisal results, (c) confirm understanding of the process issues, and (d) provide guidance regarding focus, timing, and priorities of the recommendations report and follow-on activities.

Required Practices None. If the option is selected, hold a private meeting between the appraisal team leader and the sponsor, including any participants invited by the sponsor.

Parameters and Limits If an executive session is conducted, the confidentiality and non-attribution of data sources must be maintained.
Multiple sessions may be held if necessary, targeted at the information needs of the executive audience.

Continued on next page

3.1.2 Conduct Executive Session(s) (continued)

Optional Practices

Attendance by the entire appraisal team at the executive sessions is a tailoring option.

The executive session is also an appropriate opportunity to review appraisal performance with the appraisal sponsor and/or senior site manager, and planned versus actual execution of the appraisal plan, including method tailoring. This provides additional input on the appropriate expectations for interpreting and handling the appraisal results.

The draft ADS may optionally be provided during the executive session instead of at the conclusion of the final findings briefing as discussed in activity 3.1.1, Present Final Findings.

Implementation Guidance

The intent of the executive sessions is to ensure that the appraisal sponsor and/or the senior site manager have a sound understanding of the appraisal results. Any feedback obtained from these executive sessions should be recorded. All rules for confidentiality and non-attribution are still in effect.



3.1.3 Plan for Next Steps

Activity Description	<p>Following the delivery of the appraisal results, a plan for follow-on activities is determined. The planned follow-on activities are typically defined in the appraisal plan, reflecting sponsor requests for additional appraisal tasks and products necessary to meet appraisal objectives, or for a commitment to take action upon the appraisal results. Follow-on activities may include</p> <ul style="list-style-type: none">• development of a final report• development of a recommendations report or briefing• generation or update of a process improvement plan
Required Practices	None.
Parameters and Limits	None.
Optional Practices	Planning for next steps is an optional, but recommended, appraisal activity.
Implementation Guidance	<p>Planning for next steps includes optional activities such as</p> <ul style="list-style-type: none">• development of a final report by the appraisal team, summarizing the appraisal results for delivery to the appraisal sponsor• submission of appraisal team recommendations for action upon the appraisal findings• generation of a process improvement action plan for the organizational unit to act upon the appraisal findings <p>In addition to specifying the activities to be performed, these plans usually include the assignment of responsibility, schedule, and estimated resources for the implementation of the follow-on actions. The plans established can be used to track the progress of the follow-on activities over time.</p>
Implementation Guidance	Findings and recommendations from the appraisal team can be used by the organizational unit to establish action plans for process improvement. This is an optional output most often used in internal process improvement or process-monitoring applications of the appraisal method.
Process Improvement Action Planning	<p>Recommendations often include a prioritized list of improvement activities, including the development of an improvement plan that defines the tasks, schedules, and resources necessary for implementation.</p> <p>Follow-on appraisals are usually performed to verify improvement progress. This might include a combination of Class A, Class B, and Class C appraisals (refer to the ARC for additional details).</p>

Continued on next page

3.1.3 Plan for Next Steps (continued)

Implementation Guidance The purpose of the final report is to provide details or explanations beyond what was contained in the final findings. The generation of an appraisal final report is an optional activity that, if requested by the appraisal sponsor, documents the execution of the appraisal, contains detailed appraisal findings, and forms a basis for action planning. This baseline is used for subsequent reports and follow-on actions, and also may be an input for use in subsequent appraisals.

Final Report

Items contained or referenced in the final report, either in their entirety or as a subset, might include

- executive summary of the appraisal process and results
- appraisal input (see process 1.1)
- appraisal plan (see process 1.2)
- appraisal record (see process 3.2)

The final report should be completed as soon after the appraisal as possible, preferably within four weeks. The appraisal team leader usually generates the final report; other team members may also contribute.

The format and content of the final report may vary according to its intended use by the appraisal sponsor. In its simplest form, this could be a set of notes annotated to the final findings, elaborating on some aspect of the findings or capturing essential comments or recommendations from the appraisal team.

Implementation Guidance If requested by the appraisal sponsor, appraisal team recommendations for taking action on the appraisal results can be provided. These recommendations can provide momentum to the appraisal follow-up by serving as a link between the appraisal findings and subsequent decision making or action plans. The emphasis of these recommendations depends on the appraisal sponsor's objectives and planned use of the appraisal results, as defined in the appraisal input. This can vary widely based on the context in which the appraisal method is applied (e.g., internal process improvement, supplier selection, process monitoring).

Recommendations Report

The recommendations report should be completed as soon after the appraisal on-site period as possible. Depending on the nature, complexity, and use of the recommendations, this may take as long as two months to produce.

Rather than generate a separate recommendations report, a common alternative is to include these recommendations in the final report.

It is important to consider the possibility that the expertise needed for making the appropriate recommendations may be beyond the level of expertise reflected on the team.



3.2 Package and Archive Appraisal Assets

Purpose	Preserve important data and records from the appraisal, and dispose of sensitive materials in an appropriate manner.
Entry Criteria	<ul style="list-style-type: none">• Appraisal has been conducted.• Results have been delivered to the sponsor.• All appropriate data have been collected and retained during the appraisal.
Inputs	<ul style="list-style-type: none">• Appraisal data<ul style="list-style-type: none">- appraisal input- appraisal plan- final findings- objective evidence• Appraisal team artifacts<ul style="list-style-type: none">- notes- documented practice implementation gaps- preliminary findings- document library
Activities	<p>3.2.1 Collect Lessons Learned 3.2.2 Generate Appraisal Record 3.2.3 Provide Appraisal Feedback to CMMI Steward 3.2.4 Archive and/or Dispose of Key Artifacts</p>
Outputs	<ul style="list-style-type: none">• Appraisal Record• Completed forms and checklists• Sanitized data (as appropriate and agreed upon during planning)• Lessons learned (appraisal team, organization)
Outcome	Data and artifacts are appropriately archived or destroyed. The team has captured lessons and data to help improve the appraisal process. Requirements for providing appraisal artifacts to stakeholders and the CMMI Steward are met.
Exit Criteria	<ul style="list-style-type: none">• Appraisal assets are baselined and archived.• Required reports are delivered to the appropriate stakeholders.• Artifacts containing sensitive information are disposed of in an appropriate manner.

Continued on next page

3.2 Package and Archive Appraisal Assets (continued)

Key Points	Protect the confidentiality of sensitive data while distributing and archiving appraisal assets. Bundle related information together whenever appropriate.
Tools and Techniques	<p>The use of electronic (database) tools for managing appraisal data often provides assistance in ensuring the integrity of baselines, as well as repackaging information for archival purposes. Electronic tools allow the Lead Appraiser to remove traceability information so that data can be provided to the appropriate people while preserving the anonymity of the data sources.</p> <p>Electronic tools also support the submission of appraisal data to the CMMI Steward. This reduces the administrative burden, and will facilitate the analysis of appraisal method performance data. These tools also provide feedback on the consolidated analysis results to the appraisal community.</p>
Metrics	While archiving and reporting the metrics associated with the conduct of the appraisal is an important element of this activity, the metrics associated with the conduct of this activity itself are limited. The effort and calendar time consumed are collected and compared to the plan. Some appraisal team leaders will choose to maintain personal metrics associated with the artifacts described in this activity.
Verification and Validation	The Lead Appraiser Requirements Checklist guides the verification of the list of artifacts provided to the CMMI Steward. Validation is provided by the CMMI Steward upon receipt of the appraisal record.
Records	<ul style="list-style-type: none">• Appraisal Record• Lessons Learned
Tailoring	The usage mode and constraints of the appraisal, as well as the sensitivity of the data and planned use of appraisal results, may greatly affect the degree to which appraisal data is retained, sanitized, or discarded.

Continued on next page

3.2 Package and Archive Appraisal Assets (continued)

Interfaces with Other Processes

As the final process in the appraisal, this process is about collecting, packaging, and archiving those results and artifacts produced by previous processes that must become part of the appraisal record. Most notably, this includes the appraisal input, appraisal plan, and appraisal results. Additionally, sensitive or proprietary data produced by other appraisal processes must be returned to the organizational unit or destroyed.

Summary of Activities

This process performs the data collection, data management, and reporting activities necessary to close out the appraisal. Data collected throughout the appraisal is consolidated and baselined, becoming a permanent part of the appraisal record.



3.2.1 Collect Lessons Learned

Activity Description As one of the final activities in wrapping up an appraisal, teams typically record lessons learned from their experience. The purpose of these lessons learned is to document what went right, what went wrong, and any suggestions or recommendations for improving the method or its execution. The collection of lessons learned is a recommended activity for the improvement of future appraisals, but is not a method requirement.

Required Practices None.

Parameters and Limits Lessons learned must adhere to the same principles of confidentiality and non-attribution applicable to other appraisal results.

Continued on next page

3.2.1 Collect Lessons Learned (continued)

Optional Practices All practices related to the collection of lessons learned are optional, but recommended. If the team has identified potential improvements to elements of the CMMI Product Suite (reference model, appraisal method, and training materials), these can be submitted as change requests to the CMMI Steward.

Implementation Guidance Capturing lessons learned is often done as a group at the end of the appraisal, while the appraisal activities are fresh in team members' minds. This can be supplemented with additional inputs from team members upon further reflection, if necessary. Appraisal team leaders forward these aggregate lessons learned, as appropriate, to various stakeholders, but always to the other team members. Team leaders and members often maintain summary lists of appraisal best practices and lessons learned as a mechanism for continuous learning and improvement, and these are used as a resource for planning subsequent appraisals.



3.2.2 Generate Appraisal Record

Activity Description Appraisal data collected throughout the appraisal is aggregated and summarized into a permanent record documenting the appraisal conduct and results. The appraisal record is delivered to the appraisal sponsor for retention.

Required Practices

- Collect and baseline appraisal data that becomes part of the permanent records provided to appraisal stakeholders.
- Document the satisfaction of all SCAMPI requirements.
- Generate the appraisal record from baselined planning and execution data collected throughout the appraisal.
- Deliver the appraisal record to the appraisal sponsor.

Parameters and Limits Required contents of the appraisal record include the following:

- dates of the appraisal
- appraisal input
- appraisal plan
- objective evidence, or identification thereof, sufficient to substantiate goal-rating judgments
- characterizations of practice implementation determined at the instantiation level and aggregated at the organizational unit level
- identification of the appraisal method (and version) used along with any tailoring options
- final findings
- all ratings rendered during the appraisal (goals, PAs, and maturity or capability levels)
- ADS
- the set of 15504 process profiles resulting from the appraisal (if requested by the appraisal sponsor)

Depending on the recipient and intended usage, appraisal data may be subject to being sanitized or edited in order to comply with rules for non-attribution, confidentiality, protection of proprietary information, and applicable laws, regulations, or standards (e.g., acquisition regulations or security classification). Recipients are expected to place the appropriate limitations on the access and use of the provided appraisal data.

The appraisal team leader documents in the ADS that all SCAMPI requirements were satisfied.

Continued on next page

3.2.2 Generate Appraisal Record (continued)

Optional Practices The appraisal record should also contain any additional outputs requested by the appraisal sponsor, as agreed to during appraisal planning and documented in the appraisal input.

Implementation Guidance The actual objective evidence (artifacts or portions of artifacts) need not be part of the appraisal record, but an identification of the objective evidence is required. This may be implemented by providing the PII's that were used as the basis for characterizing practice implementation decisions.

Guidance on the protection of appraisal data can be summarized based on the recipient of the data as follows:

- appraisal sponsor: replacement of specific sources (persons, projects) with non-attributable, general identifiers (e.g., numeric codes assigned to projects, roles, or data-gathering sessions). If the sponsor is separate from the appraised organization (e.g., in the case of a supplier selection context), there may be situations where confidential or proprietary data relating to the appraised organization must be removed.
 - CMMI Steward: same as for appraisal sponsor, for data that is shared by both. For data that is provided only to the CMMI Steward, the data collection vehicles (e.g., forms) are already designed to observe non-attribution and confidentiality rules. Additionally, supplied data may be subject to further sanitization to comply with acquisition or security-related restrictions.
 - senior site manager: in cases where the appraised organizational unit is separate from the appraisal sponsor, the appraised organization is typically provided only with appraisal results and not data related to planning and decision making, or data that makes use of the results.
-



3.2.3 Provide Appraisal Feedback to CMMI Steward

Activity Description	Appraisal data required by the CMMI Steward is collected and reported. This includes a subset of the contents of the appraisal record, as well other data used by the Steward to aggregate and analyze appraisal performance data for reporting to the community and monitoring the quality of performed appraisals.
Required Practices	Submit the completed appraisal report as required by the CMMI Steward.
Parameters and Limits	The CMMI Steward defines the specific set of data required for submission at the completion of an appraisal. Submission of the appraisal report is required for the appraisal to be recorded in the Steward's database of appraisal results. This is also a requirement established by the Steward to maintain Lead Appraiser authorization.
Optional Practices	If the objective evidence is available in electronic form, it can be included as part of the appraisal report submitted to the CMMI Steward.
Implementation Guidance	<p>The appraisal team leader is responsible for ensuring that appraisal feedback required by the CMMI Steward is collected and reported. The CMMI Steward, as custodian of the product suite and the Appraiser Program, has several objectives in seeking appraisal feedback:</p> <ul style="list-style-type: none">• characterization of the state of the practice in the appraisal community, for the collection and distribution of effective appraisal techniques• analysis of reported appraisal data to obtain an understanding of appraisal performance for continuous improvement• quality control within the Appraiser Program, to ensure a high level of confidence in the accuracy of appraisal results <p>Feedback is provided periodically to the community on summarized results determined from appraisal data collected.</p> <p>The format and mechanisms for the submission of this data are established by the CMMI Steward.</p>



3.2.4 Archive and/or Dispose of Key Artifacts

Activity Description After the various reports are delivered to the appropriate stakeholders and the appraisal assets have been baselined, the team leader is responsible for properly archiving and/or disposing of the appraisal data, in accordance with agreements made with the sponsor and documented in the appraisal input. The team librarian (if one is used) ensures that all organization-provided documentation and objective evidence is returned or disposed of properly. Any remaining team artifacts or notes are disposed of properly.

- Required Practices**
- Archive or dispose of key artifacts collected by the appraisal team.
 - Return objective evidence provided by the organizational unit.
-

Parameters and Limits In all usage modes of SCAMPI, strict non-attribution policies apply. Confidentiality and non-disclosure agreements established with the appraisal team members remain in effect.

Optional Practices None.

Implementation Guidance How the records will be preserved or disposed of is dependent on the usage mode of the method and the appraisal objectives that shape the current application. Confidentiality rules may differ by application. In a supplier selection usage, the results are not proprietary in that the sponsor is not a member of the appraised organization. However, results are only known to the sponsor and the recipient; competing organizations do not see the results. Confidentiality of results can be characterized as one of the following:

- known only to the recipient organization
- known to the recipient and sponsor, when they are from different organizations
- known to anyone

The sponsor is solely responsible for determining the confidentiality with which the appraisal results will be maintained. The non-attribution of data to specific individuals is the responsibility of the appraisal team. The recipient organization, if the sponsor agrees and it is planned for, may always choose to make the results known outside the organization. At a high level, this might be done for marketing and public relations reasons. Disclosures of results include the context and constraints under which the appraisal was performed (e.g., reference model scope, organizational scope), as defined by the ADS described in process 3.1, Deliver Appraisal Results.

Any annotations related to the objective evidence provided to the organization by the appraisal team should be recorded and archived for use in process improvement actions or for reuse in subsequent appraisals.



Part III: Appendices, References, and Glossary

Appendix A Appraisal Disclosure Statement

The Appraisal Disclosure Statement (ADS) provides information considered essential to adequately interpret the meaning of maturity level or capability level ratings resulting from a CMMI Class A appraisal.

The ADS is prepared by the appraisal team leader and provided to the appraisal sponsor at the conclusion of the appraisal. If the final findings briefing reports the appraisal ratings, the vehicle for reporting the ratings must be the ADS. Otherwise the appraisal team leader delivers the ADS to the sponsor as a separate document.

ADS Content

The ADS consists of the following information:

- identification of appraisal sponsor and sponsor's organizational affiliation
- identification of appraisal team leader and appraisal team members and their organizational affiliations
- identification of organizational unit appraised (the unit to which the ratings are applicable and the domains examined, as defined in the appraisal plan)
- identification of CMMI model (version, representation, and domains)
- identification of appraisal method (name and version)
- itemization of process areas rated and process areas not rated
- maturity level and/or capability level ratings assigned
- dates of on-site activity
- date of issuance of ADS
- statement affirming that all SCAMPI requirements were met
- signature of appraisal team leader (at a minimum); those of appraisal team members and appraisal sponsor are optional

Appendix B The Role of Practice Implementation Indicators in Verifying Practice Implementation

Purpose

This appendix provides a conceptual overview of the process of verifying practice implementation and the role of Practice Implementation Indicators in that process. Verification of practice implementation is an essential element of appraising the implementation of processes relative to models of best practices such as CMMI.

Verifying Practice Implementation

In this discussion, verifying CMMI practice implementation means the substantiation of practice implementation based on a review of objective evidence. For example, one might inquire as to whether a project-specific practice is implemented within a project. Alternatively, one might inquire as to whether an organization-specific practice is implemented within an organization.

Having a well-defined approach for verifying practice implementation is of critical importance from several perspectives. For the process improvement sponsor, it provides some assurance that the resources applied to the improvement effort will result in the desired outcome and that the resultant benefits can therefore be expected. For process improvement agents or champions, it enables them to know when they have succeeded with the implementation activity, and to informally monitor whether the practice continues to be implemented over time. For appraisal teams, a well-defined verification approach is essential for determining what capability level or maturity level ratings are warranted. CMMI process area goal satisfaction is predicated on implementation of the relevant specific or generic practices (or acceptable alternatives)¹. Hence verification of practice implementation is a crucial appraisal task.

¹ See “Required, Expected, and Informative Components” in Chapter 2 of the CMMI model that you are using.

Practice Implementation Indicators

The fundamental idea of Practice Implementation Indicators (PIIs) is quite simple and broadly applicable to any practice or activity. It is based on the obvious fact that the conduct of an activity or the implementation of a practice will result in “footprints”—evidence that the activity was conducted or the practice was implemented.

For example, if one balances one’s checkbook at the end of the month, there are several potential ways to confirm that this activity has indeed taken place. First, the person who engaged in the checkbook balancing activity can affirm that this activity was conducted. Second, there will likely be an entry in the checkbook register for each check or transaction to indicate that it matches with a corresponding entry in the bank’s statement. Additional artifacts could be identified.

The general idea is clear: the actual conduct of an activity leaves footprints that provide a basis for verification.

PIIs refer to the footprints that are the necessary and unavoidable consequence of practice implementation. They include information contained in artifacts and information gathered from interviews with managers and practitioners.

The Role of PIIs

ARC-compliant appraisal methods employ objective evidence obtained from one or more sources (instruments, documents, and interviews). An appraisal team bases its decisions about practice implementation on examination of this objective evidence.

Once a project or organization has an understanding of how its processes relate to the CMMI model, the stage is set for capturing the PIIs that provide the objective evidence of implementation. The work of establishing the collection of PIIs for the project(s) and/or organization provides assurance to the process improvement sponsor that the expected implementation activities have in fact resulted in alignment of the organization’s activities with the CMMI model.

This aggregation of objective evidence—the PIIs—is itself an important organizational process asset that has a number of potential uses, most notably providing an appraisal team a head start in understanding the organization’s implementation of the CMMI model. This leaves the appraisal team the task of verifying whether the objective evidence² provided is adequate for substantiation of practice implementation, rather than the more difficult, error prone, and

² The ARC defines objective evidence as “qualitative or quantitative information, records, or statements of fact pertaining to the characteristics of an item or service or to the existence and implementation of a process element, which are based on observation, measurement, or test and are verifiable.”

time-consuming task of investigating each practice to discover the objective evidence needed to substantiate implementation.

Both the appraised organization and the appraisal team have a clearer picture of what artifacts need to be provided to substantiate implementation of the practices, thereby minimizing the amount of further investigation necessary in the form of interviews and additional documentation requests. The extent to which the appraised organization can provide this information becomes a principal factor in how much further investigation may be required.

Another benefit of this approach is significantly greater reliability and accuracy of appraisal.

The PII-based approach is not meant to turn the appraisal into a documentation review exercise. It merely allows for more focused and effective use of the on-site phase and potentially a shorter on-site phase than would otherwise be the case.

Finally, the PIIs are not intended to tie the hands of model implementers or process appraisal teams. The primary value of the PIIs lies in making explicit what has heretofore been implicit and therefore subject to wide variations in interpretation and understanding. Over time, sharing of PIIs will result in a set of practice implementation scenarios (e.g., small, medium, and large organizations or projects) and a standard set of PIIs that could be used as a starting point for further customization. The particular process implementation context and the specifics of the project would determine which of the indicators make sense for that implementation. Appraisal teams would be obliged to inquire into the existence of the agreed-upon indicators, while still having the freedom to make judgments based on the facts and circumstances of the implementation.

A standard set of PIIs could establish norms within which most implementations will fall, thereby allowing efficiencies to be realized in implementation and appraisal, while at the same time recognizing that alternative implementations may be possible using alternative practices.

PII Components

PIIs have two components or dimensions: an objective evidence component and a practice implementation type component. The objective evidence component refers to the form of the objective evidence. The practice implementation type component deals with the significance of the objective evidence in relation to practice implementation.

Forms of Objective Evidence

An appraisal team bases its decisions about practice implementation on the existence of objective evidence available to it. This objective evidence can take on one or more of the following forms:

- artifacts
 - work products, which are the explicit intended consequences of practice implementation
 - artifacts that are incidental to, but indicative of, practice implementation
- affirmations
 - written or oral statements indicative of practice implementation from practitioners who carry out the activities relevant to the practice or from suppliers, customers, or other stakeholders in the practice
 - demonstrations or presentations (e.g., the demonstration of capability of a tool or other mechanism as it relates to the implementation of a practice, or a presentation explaining some aspect of the organization or project)

Note that there is not a strong distinction made in the model between artifacts and work products (see Chapter 3 in the model for an explanation of how “work product” is used). As used in the context of PIIs, work product refers to an artifact that is either explicitly mentioned in the statement of a CMMI practice or whose absence would be a strong indicator of incomplete or inadequate practice implementation. The weaker term “artifact” is used in the context of PIIs to refer to an artifact whose existence is incidental to (i.e., a side-effect of) the accomplishment of the main intent of the practice.

Types of PIIs

Using the above discussion as the framework, it is now possible to itemize the types of PIIs that might be present as a consequence of practice implementation. Table III-1 shows PII types, which collectively provide coverage for any CMMI practice. Each type is described in more detail below.

Table III-1: PII Types

PII Type	Objective Evidence Form	Generic Description
Direct	Artifact (work product)	Work product(s) that reflect (document the information content of) the establishment of {insert text from practice statement that describes object of practice enactment}.
Indirect	Artifact	Artifact(s) that are an indirect consequence (or side-effect) of the effort required to {insert text from practice statement that describes object of practice enactment}.
Direct	Affirmation	Affirmations from individuals who participated in or contributed to {insert text from practice statement that describes object of practice enactment} OR affirmations from individuals who are users of (or who can substantiate use of) {insert text from practice statement that describes object of practice enactment}.

Direct Artifact

This PII type is relevant when establishment of a work product is an integral part of practice implementation. Sometimes this is explicit, as in “Establish and maintain process action plans to address improvements to the organization’s processes and related process assets” (OPF SP 2.1-1). In other instances, it is not explicit, although it would be difficult to imagine practice implementation without the presence of one or more work products being produced. In most cases, the model document already identifies these work products.

Indirect Artifact

This PII type applies to artifacts that are produced as a natural consequence of practice enactment. The difference between this and a direct artifact PII is that this type applies to artifacts that are an indirect consequence or side-effect of practice enactment. For this reason, artifacts that are relevant to this PII will vary widely and will tend to be implementation-specific. This indicator type is especially useful when there may be doubts about whether the intent of the practice has been met (e.g., a work product exists but there is no indication of where it came from or who developed it).

Direct Affirmation

This PII type refers to either information obtained via interviews of individuals involved in the enactment of a practice or of individuals who are stakeholders (e.g., customers, suppliers) in the enactment of a practice. This type can also apply to information provided in other ways, such as demonstrations or presentations.

PII Descriptions

A PII Description (PIID) is a structure or schema defined to provide a repository for the PII information. Table III-2 shows an example of such a structure. Note that this is a notional description of the content, not a physical definition of the format.

Table III-2: A PIID Schema

Attribute	Synopsis	Remarks
Practice ID	This identifies the process area, goal, and practice that the PII is associated with.	Acronyms found in the CMMI models are used.
PII ID	This identifies the indicator type and the form of objective evidence.	Types are direct artifact, indirect artifact, and direct affirmation.
Description	This is a description of the PII as applied to this practice.	
Examples	These are examples of artifacts or affirmations that would exemplify the intent of the PII and/or exploratory questions (EQs) or “look fors” (LFs). They assist assessors in identifying relevant artifacts or eliciting relevant information.	Aim to minimize any overlap with such information that is already in the model document.
Organizational Implementation	This attribute would be filled in by the organization as part of its implementation program and provided to the appraisal team as a resource.	

Table III-3 shows an example PIID for specific practice 1.1-1 of the Project Planning process area:

Table III-3: An Example PIID

Attribute	Value
Practice ID	PP SP 1.1-1
PII ID	Direct Artifact
PII Description	Work product(s) that reflect (document the information content of) the establishment of a top-level work breakdown structure (WBS) to estimate of the scope of the project.
Examples	See Typical Work Products.
Organizational Implementation	{To be provided by the organization for a specific project implementation. }

These descriptions have a number of uses in addition to their utility during process appraisal. They can be used during the model implementation phase, after model implementation as a training vehicle for new personnel, for internal monitoring of practice implementation, etc.

Application of PIs in Model Implementation

The use of indicators has significant utility for an organization that is committed to model-based process improvement. Typically, organizations will either implement model practices directly or will ensure that the practices used in the organization effect goal achievement (through the mechanism of alternative practices).

Since models are necessarily expressed and published in an implementation-independent manner, the implementation of a model will require that an understanding of how the model intent (as expressed through goals, practices, and other model material) is to be realized in the organization be developed, documented, and operationalized. The model intent is made real through its impact on the way people work; if there is no relation between how they work and the model, the organization has not implemented the model. Thus, having an understanding of the ways in which implementation of the model relates to what people are doing in the organization is a necessary and unavoidable prerequisite to implementing the model. PIIDs provide a mechanism by which the implementation of a model practice can be described.

Application of PIIs in Process Appraisal

During the course of process appraisal, the appraisal team's primary focus is on verifying practice implementation. This is accomplished by (1) obtaining objective evidence relevant to the implementation of a practice, (2) comparing the objective evidence available with what is expected, and then (3) making a determination of practice implementation based on the difference between actual and expected evidence.

The PIIs assist the appraisal team (as well as the implementing organization) with task 1 by *providing a framework or structure that makes explicit the types of objective evidence that should be considered*. In concert with the CMMI model documentation, this provides the model basis against which the organization's actual operating practices are compared.

Note that PIIs do not prescribe what objective evidence must be present for practice implementation determinations to be made; they only make explicit what is reasonable for an appraisal team to consider. The particular circumstances and attributes of the organizational unit and/or project must all be taken into consideration when making determinations of practice implementation. As a general rule, the more objective evidence and the more PIIs represented by that objective evidence, the higher the confidence level that the practice is implemented.

The PII structure assists the appraisal team with task 2 to the extent that the team has agreed in advance on the objective evidence it *expects* to see for each process instantiation examined. In some cases it may be difficult or impossible to have completely developed a team consensus on what objective evidence must be seen (in advance). But sooner or later the appraisal team must establish a consensus view on what is reasonable to expect, since it is only the presence of that consensus view that permits a determination of practice implementation to be made.

The final practice implementation determination task is that of developing a team consensus on whether the practice is implemented for the process instantiation being examined. This decision is based on the difference between what is expected and what is observed.

Appendix C Focused Investigation Elaboration and Guidance

Concept Description

This appendix describes the use of preliminary objective evidence review, continuous consolidation of objective evidence, and practice characterization in focusing the data collection and investigation effort of the appraisal team.

Focused investigation relies on a high degree of planning, organization, and subsequent management and control of the activities of the appraisal. The concept incorporates the following activities:

- collecting preliminary objective evidence through instruments as a part of obtaining preliminary data
- creating an inventory of objective evidence collected, to support practice implementation characterization
- initially reviewing and analyzing preliminary objective evidence inventoried, to identify gaps in objective evidence supporting practice characterization
- identifying information needs to support initial preparation and refinement of the data collection plan
- continuously consolidating objective evidence collected and updating the status of practice characterization for each organizational unit instantiation (aggregated up to the organizational unit)

Preliminary Focused Investigation

Focused investigation should be begun in the Appraisal Planning phase of the appraisal. Focused investigation is best initiated with a practice-based initial data collection instrument that documents the organizational unit's implementation of the practices of the CMMI model for each instantiation within the scope of the appraisal. Preliminary data may be collected using instruments such as questionnaires, surveys, and presentations. This data should include a preliminary inventory of Practice Implementation Indicators.

An inventory and review of this data provides an important initial determination of the gaps in the data available supporting practice implementation, as well as what information and objective evidence is needed. These activities are performed as part of the Obtain and Ana-

lyze Preliminary Objective Evidence process. The more complete and comprehensive this early data collection and analysis is, the better prepared the organizational unit will be for the appraisal.

These preliminary information needs can provide the foundation of the data collection plan for the remainder of the appraisal process. They also provide the foundation for the readiness review and any necessary adjustments in the appraisal plan, providing a clearer set of initial expectations for the magnitude of the appraisal effort. Data gaps found can result in additional document requests and other data collection plans. These activities are performed as an early part of the Prepare for Collection of Objective Evidence process.

Continuous Consolidation and Tracking

Following the initial focused investigation effort, a data collection plan is developed and followed. Data collection activities are described by the Examine Objective Evidence process. This process typically consists of planned data collection activities that include presentations, document reviews, and interviews.

As these data collection activities are performed, practice characterization and strengths and weaknesses are recorded and added to the existing objective evidence inventory, and continuously reviewed (see the Verify and Validate Objective Evidence and Document Objective Evidence processes). Additional data collected is added and consolidated with the data already collected to continuously provide the assessment team with a view of their progress against the data collection plan and model coverage. This is referred to as “continuous consolidation.”

Monitoring and controlling the data collection plan and model coverage is an essential aspect of performing focused investigation and continuous consolidation. The appraisal team must be able to record, monitor, and track progress against the data collection plan. This may be done in several ways, but generally requires the use of some mechanism for recording the progress towards determining practice characterization for each reference model practice within the scope of the appraisal. As data is collected for each practice, and for each sample instantiation of the organizational unit being appraised, it is also useful to have some mechanism for easily comparing and consolidating practice implementation. Instruments and automated tools that support the Conduct Appraisal phase of the appraisal can greatly facilitate this.

Perhaps the most important feature of focused investigation is the appraisal team’s awareness of its status regarding determination of practice characterization and goal satisfaction. The team continually maintains an understanding of how the data collected supports the implementation of each practice for each instantiation of the organizational unit, and what additional objective evidence is needed. This allows the team to update the data collection plan to optimally refocus their efforts during the data collection activities.

Appendix D ARC/MDD Traceability Table

Table III-4: ARC Traceability

ARC ID	ARC Requirement	MDD Process	MDD Activity	Notes/Comments
4	Requirements for CMMI Appraisal Methods			
4.1	Responsibilities			Key roles and responsibilities are addressed in process 1.3, Select and Prepare Team.
4.1.1	The method shall define the responsibilities of the appraisal sponsor, which at a minimum shall include the following activities:			
4.1.1.a	(ABC) Verify that the appraisal team leader has the appropriate experience, knowledge, and skills to take responsibility for and lead the appraisal.	1.3 Select and Prepare Team	1.3.1 Identify Team Leader	
4.1.1.b	(ABC) Ensure that the appropriate organizational units or sub-units (e.g., projects, functional units) participate in the appraisal.	1.1 Analyze Requirements	1.1.3 Determine Appraisal Scope	
4.1.1.c	(ABC) Support appraisal method provisions for ensuring non-attribution to appraisal participants.	1.1 Analyze Requirements	1.1.5 Obtain Commitment to Appraisal Input	Non-attribution is also addressed throughout the MDD in discussions of team members (1.3.3), preliminary findings (2.2.3), documentation of objective evidence (2.3), reporting (3.1), and recording (3.2).
4.1.1.d	(ABC) Ensure that resources are made available to conduct the appraisal.	1.2 Develop Appraisal Plan	1.2.6 Obtain Commitment to Appraisal Plan	Resources are identified in several sections of 1.2, Develop Appraisal Plan, and commitment is obtained in 1.2.6.
4.1.1.e	(ABC) Review and approve the appraisal input prior to the beginning of data collection by the appraisal team.	1.1 Analyze Requirements	1.1.5 Obtain Commitment to Appraisal Input	

ARC ID	ARC Requirement	MDD Process	MDD Activity	Notes/Comments
4.1.2	The method shall define the responsibilities of the appraisal team leader, which at a minimum shall include the following activities:	1.3 Select and Prepare Team	1.3.1 Identify Team Leader	Appraisal team leader responsibilities are defined throughout, but are summarized in 1.3.1.
4.1.2.a	(ABC) Ensure that the appraisal is conducted in accordance with the method's documented process.	1.2 Develop Appraisal Plan	1.2.1 Tailor Method	Tailoring descriptions (1.2.1) and the SCAMPI Implementation Model are the primary means to identify variation in the method. The appraisal team leader completes a SCAMPI Implementation Checklist and certifies in the Appraisal Disclosure Statement (3.2.2) that method requirements were met.
4.1.2.b	(ABC) Confirm the sponsor's commitment to proceed with the appraisal.	1.1 Analyze Requirements	1.1.5 Obtain Commitment to Appraisal Input	The primary mechanism to describe and document sponsor commitment and appraisal objectives is the appraisal input (1.1.5).
4.1.2.c	(ABC) Ensure that appraisal participants are briefed on the purpose, scope, and approach of the appraisal.	1.4 Obtain and Analyze Preliminary Objective Evidence	1.4.1 Prepare Participants	
4.1.2.d	(ABC) Ensure that all appraisal team members have the appropriate experience, knowledge, and skills in the appraisal reference model and appraisal method; the necessary competence to use instruments or tools chosen to support the appraisal; and access to documented guidance on how to perform the defined appraisal activities.	1.3 Select and Prepare Team	1.3.3 Prepare team	Also addressed by selection of team members with appropriate qualifications in 1.3.2.
4.1.2.e	(ABC) Verify and document that the appraisal method requirements have been met.	3.2 Package and Archive Appraisal Assets	3.2.2 Generate Appraisal Record	Tailoring descriptions (1.2.1) and the SCAMPI Implementation Model are the primary means to identify variation in the method. The appraisal team leader completes a SCAMPI Implementation Checklist and certifies in the Appraisal Disclosure Statement (3.2.2) that method requirements were met.
4.2	Appraisal Method Documentation			
4.2.1	The method shall be documented and, at a minimum, include	MDD, V1.1	All	

ARC ID	ARC Requirement	MDD Process	MDD Activity	Notes/Comments
4.2.1.a	(ABC) identification of the CMMI models (version, discipline, and representation [staged or continuous]) with which the method can be used			
4.2.1.b	(ABC) identification of the ARC version upon which the appraisal method is based	Method Context		ARC v1.1
4.2.1.c	(ABC) identification of which CMMI appraisal requirements are satisfied by the method, along with the CMMI appraisal class membership (if applicable)	Method Context		SCAMPI addresses all ARC Class A method requirements.
4.2.1.d	(ABC) activity descriptions, artifacts, and guidance that implement each of the appraisal requirements		(All phases, processes, activities)	MDD process descriptions in Section 3.
4.2.1.e	(A) declaration as to whether or not the method supports 15504-conformant appraisals			Executive Summary
4.2.2	The method documentation shall provide guidance for			
4.2.2.a	(ABC) identifying an appraisal's purpose, objectives, and constraints	1.1 Analyze Requirements	1.1.1 Determine Appraisal Objectives	
4.2.2.b	(ABC) determining the suitability of the appraisal method relative to the appraisal's purpose, objectives, and constraints	1.1 Analyze Requirements	1.1.1 Determine Appraisal Objectives	Also addressed by commitment to appraisal input (1.1.5) and selection of appraisal usage mode (Modes of Usage).
4.2.3	The method documentation shall provide guidance for identifying the scope of the CMMI model(s) to be used for the appraisal:	1.1 Analyze Requirements	1.1.3 Determine Appraisal Scope	
4.2.3.a	(ABC) process areas to be investigated (continuous and staged representations)	1.1 Analyze Requirements	1.1.3 Determine Appraisal Scope	
4.2.3.b	(ABC) capability levels to be investigated for each process area (continuous representation)	1.1 Analyze Requirements	1.1.3 Determine Appraisal Scope	
4.2.4	The method documentation shall provide guidance for identifying the organizational unit to be appraised:	1.1 Analyze Requirements	1.1.3 Determine Appraisal Scope	
4.2.4.a	(ABC) the sponsor of the appraisal and the sponsor's relationship to the organizational unit being appraised	1.1 Analyze Requirements	1.1.1 Determine Appraisal Goals	

ARC ID	ARC Requirement	MDD Process	MDD Activity	Notes/Comments
4.2.4.b	(ABC) projects within the organizational unit that will participate	1.1 Analyze Requirements	1.1.3 Determine Appraisal Scope	Selection of sample projects that are representative of the organizational unit is addressed by the appraisal input (1.1) and appraisal plan (1.2).
4.2.4.c	(ABC) functional elements of the organizational unit that will participate	1.1 Analyze Requirements	1.1.3 Determine Appraisal Scope	Selection of sample projects that are representative of the organizational unit is addressed by the appraisal input (1.1) and appraisal plan (1.2).
4.2.4.d	(ABC) names and affiliations (organizational units) of participants in the appraisal activities	1.1 Analyze Requirements	1.1.5 Obtain Commitment to Appraisal Input	Appraisal participants are among the resources identified in 1.2.2.
4.2.5	The method documentation shall provide guidance for selecting appraisal team members and criteria for qualification including	1.3 Select and Prepare Team	1.3.2 Select Team Members	
4.2.5.a	(ABC) technical experience (discipline-specific)	1.3 Select and Prepare Team	1.3.2 Select Team Members	
4.2.5.b	(ABC) management experience	1.3 Select and Prepare Team	1.3.2 Select Team Members	
4.2.5.c	(ABC) experience, knowledge, and skills in the appraisal reference model and appraisal method	1.3 Select and Prepare Team	1.3.2 Select Team Members	
4.2.6	The method documentation shall provide guidance for an appraisal team leader's qualification criteria, including	1.3 Select and Prepare Team	1.3.1 Identify Team Leader	Requirements for SCAMPI Lead Appraisers are defined and verified via the SEI Appraiser Program. Specific qualifications and requirements are available on the SEI web site.
4.2.6.a	(ABC) training and experience using the appraisal reference model	1.3 Select and Prepare Team	1.3.1 Identify Team Leader	
4.2.6.b	(ABC) training and experience using the appraisal method	1.3 Select and Prepare Team	1.3.1 Identify Team Leader	
4.2.6.c	(ABC) experience in delivering training, managing teams, facilitating group discussions, and making presentations	1.3 Select and Prepare Team	1.3.1 Identify Team Leader	This is also addressed by the SCAMPI Lead Assessor candidate selection criteria published on the SEI Web.
4.2.7	(ABC) The method documentation shall provide guidance for determining the appropriate size of the appraisal team.	1.3 Select and Prepare Team	1.3.2 Select Team Members	
4.2.8	(ABC) The method documentation shall provide guidance on the roles and responsibilities of appraisal team members.	1.3 Select and Prepare Team	1.3.2 Select Team Members	

ARC ID	ARC Requirement	MDD Process	MDD Activity	Notes/Comments
4.2.9	(ABC) The method documentation shall provide guidance addressing the responsibilities of the appraisal sponsor.	1.1 Analyze Requirements	1.1.5 Obtain Commitment to Appraisal Input	Sponsor responsibilities are throughout, but are primarily defined in 1.1, Analyze Requirements, and 1.2, Develop Appraisal Plan.
4.2.10	(ABC) The method documentation shall provide guidance addressing the responsibilities of the appraisal team leader.	1.3 Select and Prepare Team	1.3.1 Identify Team Leader	Appraisal team leader responsibilities are defined throughout, but are summarized in 1.3.1.
4.2.11	(ABC) The method documentation shall provide guidance for estimating the resources required to conduct the appraisal (including the amount of time required to conduct an appraisal).	1.2 Develop Appraisal Plan	1.2.3 Determine Cost and Schedule	Estimates of appraisal resources are addressed throughout development of the appraisal plan in 1.2.
4.2.12	(ABC) The method documentation shall provide guidance for appraisal logistics.	1.2 Develop Appraisal Plan	1.2.4 Plan and Manage Logistics	
4.2.13	(ABC) The method documentation shall provide guidance for collecting relevant data on the organizational unit and associating the data to the specific and generic practices of the appraisal reference model.	2.1 Examine Objective Evidence	2.1*	Addressed by individual sections of 2.1 related to sources of objective evidence.
4.2.14	(ABC) The method documentation shall provide guidance for creating findings, including both strengths and weaknesses relative to the appraisal reference model.	2.2 Verify and Validate Objective Evidence	2.2.1 Verify Objective Evidence	Addressed in descriptions of preliminary findings (2.2.3), final findings (2.4.4), and crafting strengths and weaknesses (2.2.1). In SCAMPI v1.1, the emphasis is on identifying weaknesses and significant strengths that are expected to become part of the findings. Recording of satisfactory implementations is done by verifying PIIs (2.2) rather than by text statements.
4.2.15	(ABC) The method documentation shall provide guidance for protecting the confidentiality of appraisal data and ensuring non-attribution of data contributed by appraisal participants.	3.2 Package and Archive Appraisal Assets	3.2.4 Archive and/or Dispose of Key Artifacts	Confidentiality and non-attribution principles are addressed throughout the MDD in discussions of team members (1.3.3), preliminary findings (2.2.3), documentation of objective evidence (2.3), reporting (3.1), and recording (3.2).

ARC ID	ARC Requirement	MDD Process	MDD Activity	Notes/Comments
4.2.16	The method documentation shall provide guidance: for (1) recording traceability between the data collected during the appraisal and the findings and/or ratings, (2) the retention and safekeeping of appraisal records, and (3) compiling and maintaining an appraisal record that supports the appraisal team's findings and/or ratings and that contains the following minimum content:	3.2 Package and Archive Appraisal Assets	3.2.2 Generate Appraisal Record	See section 3.2.2 for the description and contents of the appraisal record.
4.2.16.a	(ABC) dates of appraisal	3.2 Package and Archive Appraisal Assets	3.2.2 Generate Appraisal Record	
4.2.16.b	(ABC) appraisal input	3.2 Package and Archive Appraisal Assets	3.2.2 Generate Appraisal Record	The appraisal record includes the latest version of the appraisal input, which was originally agreed to by the sponsor in 1.1.5.
4.2.16.c	(A) objective evidence, or identification thereof, sufficient to substantiate goal rating judgments	3.2 Package and Archive Appraisal Assets	3.2.2 Generate Appraisal Record	As described in 3.2.2, this may be an identification of the objective evidence rather than a full or partial copy of the actual evidence. A suitable implementation for the intent of this requirement might be the set of PII's used for practice characterization in 2.2.
4.2.16.d	(ABC) identification of appraisal method (and version) used, along with any tailoring options	3.2 Package and Archive Appraisal Assets	3.2.2 Generate Appraisal Record	See also the Appraisal Disclosure Statement (ADS) described in Appendix A.
4.2.16.e	(ABC) findings	3.2 Package and Archive Appraisal Assets	3.2.2 Generate Appraisal Record	
4.2.16.f	(A) any ratings rendered during the appraisal (goals, process areas, and maturity or capability levels)	3.2 Package and Archive Appraisal Assets	3.2.2 Generate Appraisal Record	
4.2.16.g	(A) the set of 15504 process profiles resulting from the appraisal, if requested by the appraisal sponsor	3.2 Package and Archive Appraisal Assets	3.2.2 Generate Appraisal Record	15504 process profiles are an optional output, determined by the sponsor (1.1.4) and documented in the appraisal input (1.1.5).
4.3	Planning and Preparing for the Appraisal			
4.3.1	The method shall provide for the preparation of appraisal participants by addressing, at a minimum,	1.4 Obtain and Analyze Preliminary Objective Evidence	1.4.1 Prepare Participants	

ARC ID	ARC Requirement	MDD Process	MDD Activity	Notes/Comments
4.3.1.a	(ABC) the purpose of the appraisal	1.4 Obtain and Analyze Preliminary Objective Evidence	1.4.1 Prepare Participants	
4.3.1.b	(ABC) the scope of the appraisal	1.4 Obtain and Analyze Preliminary Objective Evidence	1.4.1 Prepare Participants	
4.3.1.c	(ABC) the appraisal approach	1.4 Obtain and Analyze Preliminary Objective Evidence	1.4.1 Prepare Participants	
4.3.1.d	(ABC) the roles and responsibilities of participants in the appraisal	1.4 Obtain and Analyze Preliminary Objective Evidence	1.4.1 Prepare Participants	
4.3.1.e	(ABC) the schedule of appraisal activities	1.4 Obtain and Analyze Preliminary Objective Evidence	1.4.1 Prepare Participants	
4.3.2	(ABC) The method shall provide for the development of the appraisal input prior to the beginning of data collection by the appraisal team.	1.1 Analyze Requirements	1.1.5 Obtain Commitment to Appraisal Input	The appraisal input may be generated incrementally throughout planning, but must be approved prior to the start of data collection.
4.3.3	At a minimum, the appraisal input shall specify	1.1 Analyze Requirements	1.1.5 Obtain Commitment to Appraisal Input	Contents of the appraisal input are described throughout section 1.1. The appraisal input is approved by the sponsor in 1.1.5.
4.3.3.a	(ABC) the identity of the sponsor of the appraisal, and the sponsor's relationship to the organizational unit being appraised	1.1 Analyze Requirements	1.1.5 Obtain Commitment to Appraisal Input	
4.3.3.b	(ABC) the appraisal purpose, including alignment with business objectives	1.1 Analyze Requirements	1.1.5 Obtain Commitment to Appraisal Input	See also 1.1.1, Determine Appraisal Objectives.
4.3.3.c	(ABC) the appraisal reference model scope, including	1.1 Analyze Requirements	1.1.5 Obtain Commitment to Appraisal Input	See also 1.1.3, Determine Appraisal Scope.
4.3.3.c.1	the process areas to be investigated within the organizational unit	1.1 Analyze Requirements	1.1.5 Obtain Commitment to Appraisal Input	
4.3.3.c.2	the highest maturity level and/or capability level to be investigated for each process area within the appraisal scope	1.1 Analyze Requirements	1.1.5 Obtain Commitment to Appraisal Input	
4.3.3.d	(ABC) the organizational unit that is the subject of the appraisal	1.1 Analyze Requirements	1.1.5 Obtain Commitment to Appraisal Input	See also 1.1.3, Determine Appraisal Scope.

ARC ID	ARC Requirement	MDD Process	MDD Activity	Notes/Comments
4.3.3.e	(ABC) the process context, which, at a minimum, shall include	1.1 Analyze Requirements	1.1.5 Obtain Commitment to Appraisal Input	
4.3.3.e.1	the size of the organizational unit	1.1 Analyze Requirements	1.1.5 Obtain Commitment to Appraisal Input	
4.3.3.e.2	the demographics of the organizational unit	1.1 Analyze Requirements	1.1.5 Obtain Commitment to Appraisal Input	
4.3.3.e.3	the application domain of the products or services of the organizational unit	1.1 Analyze Requirements	1.1.5 Obtain Commitment to Appraisal Input	
4.3.3.e.4	the size, criticality, and complexity of the products or services	1.1 Analyze Requirements	1.1.5 Obtain Commitment to Appraisal Input	
4.3.3.e.5	the quality characteristics of the products or services (e.g., defect density, reliability)	1.1 Analyze Requirements	1.1.5 Obtain Commitment to Appraisal Input	
4.3.3.f	(ABC) the appraisal constraints, which, at a minimum, shall include	1.1 Analyze Requirements	1.1.5 Obtain Commitment to Appraisal Input	See also 1.1.2, Determine Appraisal Constraints.
4.3.3.f.1	availability of key resources (e.g., staffing, funding, tools, facilities)	1.1 Analyze Requirements	1.1.5 Obtain Commitment to Appraisal Input	
4.3.3.f.2	schedule constraints	1.1 Analyze Requirements	1.1.5 Obtain Commitment to Appraisal Input	
4.3.3.f.3	the maximum amount of time to be used for the appraisal	1.1 Analyze Requirements	1.1.5 Obtain Commitment to Appraisal Input	
4.3.3.f.4	specific process areas or organizational entities to be excluded from the appraisal	1.1 Analyze Requirements	1.1.5 Obtain Commitment to Appraisal Input	
4.3.3.f.5	the minimum, maximum, or specific sample size or coverage that is desired for the appraisal	1.1 Analyze Requirements	1.1.5 Obtain Commitment to Appraisal Input	
4.3.3.f.6	the ownership of the appraisal outputs and any restrictions on their use	1.1 Analyze Requirements	1.1.5 Obtain Commitment to Appraisal Input	
4.3.3.f.7	controls on information resulting from a confidentiality agreement	1.1 Analyze Requirements	1.1.5 Obtain Commitment to Appraisal Input	
4.3.3.f.8	non-attribution of appraisal data to associated sources	1.1 Analyze Requirements	1.1.5 Obtain Commitment to Appraisal Input	

ARC ID	ARC Requirement	MDD Process	MDD Activity	Notes/Comments
4.3.3.g	(ABC) the identity of the CMMI models used, including the version, discipline, and representation (staged or continuous)	1.1 Analyze Requirements	1.1.5 Obtain Commitment to Appraisal Input	See also 1.1.3, Determine Appraisal Scope.
4.3.3.h	(ABC) the criteria for experience, knowledge, and skills of the appraisal team leader who is responsible for the appraisal	1.1 Analyze Requirements	1.1.5 Obtain Commitment to Appraisal Input	See also 1.3.1, Identify Team Leader.
4.3.3.i	(ABC) the identity and affiliation of the appraisal team members, including the appraisal team leader, with their specific responsibilities for the appraisal	1.1 Analyze Requirements	1.1.5 Obtain Commitment to Appraisal Input	See also 1.2.2, Identify Participants and 3.3.2, Select Team Members.
4.3.3.j	(ABC) the identity (name and organizational affiliation) of appraisal participants and support staff, with specific responsibilities for the appraisal	1.1 Analyze Requirements	1.1.5 Obtain Commitment to Appraisal Input	See also 1.2.2, Identify Participants.
4.3.3.k	(ABC) any additional information to be collected during the appraisal to support achievement of the appraisal objectives	1.1 Analyze Requirements	1.1.5 Obtain Commitment to Appraisal Input	See also 1.1.4, Determine Outputs.
4.3.3.l	(ABC) a description of the planned appraisal outputs, including ratings to be generated (process areas, maturity level)	1.1 Analyze Requirements	1.1.5 Obtain Commitment to Appraisal Input	See also 1.1.4, Determine Outputs.
4.3.3.m	(ABC) anticipated follow-on activities (e.g., reports, appraisal action plans, re-appraisal)	1.1 Analyze Requirements	1.1.5 Obtain Commitment to Appraisal Input	See also 1.1.4, Determine Outputs.
4.3.3.n	(ABC) planned tailoring of the appraisal method and associated tradeoffs, including the sample size or coverage of the organizational unit	1.1 Analyze Requirements	1.1.5 Obtain Commitment to Appraisal Input	See also 1.2.1, Tailor Method.
4.3.4	(ABC) The method shall require that the appraisal input, and any changes to the appraisal input, shall be agreed to by the sponsor (or the delegated authority) and documented in the appraisal record .	1.1 Analyze Requirements	1.1.5 Obtain Commitment to Appraisal Input	
4.3.5	The method shall require the development of an appraisal plan that, at a minimum, specifies	1.2 Develop Appraisal Plan	1.2.6 Obtain Commitment to Appraisal Plan	The appraisal plan is described throughout section 1.2. Completion and agreement of plan contents is described in 1.2.6.
4.3.5.a	(ABC) the appraisal input	1.2 Develop Appraisal Plan	1.2.6 Obtain Commitment to Appraisal Plan	
4.3.5.b	(ABC) the activities to be performed in conducting the appraisal	1.2 Develop Appraisal Plan	1.2.6 Obtain Commitment to Appraisal Plan	
4.3.5.c	(ABC) resources and schedule assigned to appraisal activities	1.2 Develop Appraisal Plan	1.2.6 Obtain Commitment to Appraisal Plan	See also 1.2.2, Identify Needed Resources, and 3.2.3, Determine Cost and Schedule.

ARC ID	ARC Requirement	MDD Process	MDD Activity	Notes/Comments
4.3.5.d	(ABC) appraisal logistics	1.2 Develop Appraisal Plan	1.2.6 Obtain Commitment to Appraisal Plan	See also 1.2.4, Plan and Manage Logistics.
4.3.5.e	(ABC) mitigation steps to address risks associated with appraisal execution	1.2 Develop Appraisal Plan	1.2.6 Obtain Commitment to Appraisal Plan	See also 1.2.5, Document and Manage Risks.
4.3.5.f	(A) the criteria to verify that the requirements of ISO/IEC 15504 have been met, if requested by the appraisal sponsor	1.2 Develop Appraisal Plan	1.2.6 Obtain Commitment to Appraisal Plan	
4.4	Appraisal Data Collection			
4.4.intro	Appraisal teams base their findings on observations that, in turn, are based on objective evidence gathered from one or more sources. The requirements in this section identify the sources of objective evidence recognized by CMMI appraisal methods. As indicated in Appendix A, all three sources of objective evidence identified below are required for Class A appraisal methods. At least two sources are required for Class B methods, one of which must be interviews. At least one source is required for Class C methods.			Presentations (2.1.2) are also a source of objective evidence in SCAMPI v1.1.
4.4.1	(See Appendix A)The method shall collect data by administering instruments (e.g., questionnaires, surveys).	2.1 Examine Objective Evidence	2.1.1 Examine Objective Evidence from Instruments	
4.4.2	(See Appendix A) The method shall collect data by conducting interviews (e.g., with project leaders, managers, practitioners).	2.1 Examine Objective Evidence	2.1.4 Examine Objective Evidence from Interviews	
4.4.3	(See Appendix A) The method shall collect data by reviewing documentation (e.g., organizational policies, project procedures, and implementation-level work products).	2.1 Examine Objective Evidence	2.1.3 Examine Objective Evidence from Documents	
4.5	Data Consolidation and Validation			
4.5.1	(AB) The method shall require appraisal team consensus in decisions when determining the validity of observations, creating findings, and establishing ratings.	2.4 Generate Appraisal Results	2.4.1 Derive Findings and Rate Goals	Use of consensus as a team decision-making technique is discussed throughout applicable sections of the MDD. A summary of consensus decisions needed is depicted in “Data Collection, Rating, and Reporting.”
4.5.2	The method shall require a mechanism for consolidating the data collected during an appraisal into accurate observations according to the following criteria:	2.3 Document Objective Evidence	2.3.3 Document Practice Implementation Gaps	

ARC ID	ARC Requirement	MDD Process	MDD Activity	Notes/Comments
4.5.2.a	(ABC) The observation was derived from objective evidence seen or heard during data collection sessions.	2.3 Document Objective Evidence	2.3.3 Document Practice Implementation Gaps	See also descriptions of verifying practice implementation indicator types (direct, indirect, affirmation) in 2.2.1.
4.5.2.b	(ABC) The observation is clearly worded, phrased without attribution, and expressed in terminology used at the organizational unit.	2.3 Document Objective Evidence	2.3.3 Document Practice Implementation Gaps	
4.5.2.c	(ABC) The observation is relevant to the appraisal reference model and can be associated with a specific model component.	2.3 Document Objective Evidence	2.3.3 Document Practice Implementation Gaps	
4.5.3	The method shall require a mechanism for validating each accurate observation according to the following criteria:	2.2 Verify and Validate Objective Evidence	2.2.1 Verify Objective Evidence	All sections of 2.2 apply.
4.5.3.a	(AB) The observation is corroborated.	2.2 Verify and Validate Objective Evidence	2.2.1 Verify Objective Evidence	In SCAMPI v1.1, corroboration is addressed by method requirements for a combination of indicator types (direct, indirect, affirmation) as described in 2.2.1.
4.5.3.b	(AB) The observation is consistent with other validated observations. (Validated observations cannot be both true and mutually inconsistent; in aggregate, they constitute a set of truths about the organizational unit that must be consistent.)	2.2 Verify and Validate Objective Evidence	2.2.1 Verify Objective Evidence	In SCAMPI v1.1, consistency is addressed by method requirements for a combination of indicator types (direct, indirect, affirmation) as described in 2.2.1.
4.5.4	The method shall require the following minimum set of criteria to be satisfied in order for an observation to be considered “corroborated”:	2.2 Verify and Validate Objective Evidence	2.2.1 Verify Objective Evidence	
4.5.4.a	(AB) The observation is based on data from at least two different sources (e.g., the data should originate from at least two different individuals).	2.2 Verify and Validate Objective Evidence	2.2.1 Verify Objective Evidence	In SCAMPI v1.1, corroboration is addressed by method requirements for a combination of indicator types (direct, indirect, affirmation) as described in 2.2.1.
4.5.4.b	(AB) The observation is based on data from at least two different data-gathering sessions.	2.2 Verify and Validate Objective Evidence	2.2.1 Verify Objective Evidence	In SCAMPI v1.1, corroboration is addressed by method requirements for a combination of indicator types (direct, indirect, affirmation) as described in 2.2.1.

ARC ID	ARC Requirement	MDD Process	MDD Activity	Notes/Comments
4.5.4.c	(AB) At least one of the two data points must reflect work actually being done (e.g., process area implementation).	2.2 Verify and Validate Objective Evidence	2.2.1 Verify Objective Evidence	In SCAMPI v1.1, this is addressed by requirements for a direct artifact from each project for each practice (2.2.1). Affirmations also reflect work being done, but are not necessarily required from each project for each practice; affirmations are used to corroborate direct artifacts.
4.5.5	The method shall require a mechanism for determining that sufficient data has been collected to cover the scope of the appraisal, according to the following minimum set of rules:	2.2 Verify and Validate Objective Evidence	2.2.1 Verify Objective Evidence	Coverage is addressed by requirements for objective evidence from each project for each practice (2.2.1). See also 1.5.3, Replan Data Collection, for collection of additional objective evidence necessary to obtain sufficient coverage.
4.5.5.a	(A) A specific or generic practice has sufficient data coverage if validated observations exist for the practice and	2.2 Verify and Validate Objective Evidence	2.2.1 Verify Objective Evidence	
4.5.5.a.1	are adequate to understand the extent of implementation of the practice	2.2 Verify and Validate Objective Evidence	2.2.1 Verify Objective Evidence	
4.5.5.a.2	are representative of the organizational unit	2.2 Verify and Validate Objective Evidence	2.2.1 Verify Objective Evidence	
4.5.5.a.3	are representative of the life-cycle phases in use within the organizational unit	2.2 Verify and Validate Objective Evidence	2.2.1 Verify Objective Evidence	See 3.1.3 for selection of instantiations representative of the organizational unit.
4.5.5.b	(A) In a staged representation, a process area has sufficient data coverage if all of its specific and generic practices have sufficient data coverage.	2.2 Verify and Validate Objective Evidence	2.2.1 Verify Objective Evidence	See also descriptions of documenting objective evidence in 3.8, and rating in 3.9.
4.5.5.c	(A) In a continuous representation, a process area has sufficient data coverage if all of its specific practices and the generic practices within the appraisal scope have sufficient data coverage up through the capability level being investigated for the process area (e.g., the target capability level).	2.2 Verify and Validate Objective Evidence	2.2.1 Verify Objective Evidence	
4.5.6	(A) The method shall require a mechanism for consolidating observations into draft findings of strengths and weaknesses relative to the appraisal reference model.	2.2 Verify and Validate Objective Evidence	3.7.3 Validate Practice Implementation Gaps	Preliminary findings are described in 3.7.3.

ARC ID	ARC Requirement	MDD Process	MDD Activity	Notes/Comments
4.5.7	(A) The method shall require that the appraisal participants be presented with the draft findings in order to solicit their responses for verification of the findings' accuracy and clarity.	2.2 Verify and Validate Objective Evidence	3.7.3 Validate Practice Implementation Gaps	Validation of preliminary findings is addressed in 3.7.3.
4.6	Rating			
4.6.1	The method shall define a rating process that specifies, at a minimum, the following:	2.4 Generate Appraisal Results	2.4*	Descriptions of rating are addressed by all activities in section 2.4. Variants for rating using staged and continuous representations are provided.
4.6.1.a	(A) An appraisal team can rate a specific or generic goal when valid observations for each practice related to the goal meet the method's defined data coverage criteria.	2.4 Generate Appraisal Results	2.4.1 Derive Findings and Rate Goals	See also descriptions relating to collection and verification of objective evidence (2.2), and sufficiency of coverage (2.3).
4.6.1.b	(A) An appraisal team can rate a process area when it has rated each of the process area's specific goals and generic goals within the appraisal scope.	2.4 Generate Appraisal Results	2.4.2a Determine Process Area Capability Level 3.9.2b Determine Satisfaction of Process Areas	
4.6.1.c	(A)An appraisal team can determine a maturity level rating once it has rated all of the process areas within that level and each level below.	2.4 Generate Appraisal Results	2.4.3b Determine Maturity Level	
4.6.1.d	(A) An appraisal team can determine the capability level of a process area when it has rated each of the generic goals at or below the target capability level.	2.4 Generate Appraisal Results	2.4.3a Derive Process Area Capability Profile	
4.6.2	(A)The method shall require that maturity level ratings and/or capability level ratings be based on the definitions of capability levels and maturity levels in the CMMI models.	2.4 Generate Appraisal Results	2.4.3a Derive Process Area Capability Profile 2.4.3b Determine Maturity Level	Also see "Data Collection, Rating, and Reporting."
4.6.3	The method shall rate each specific and generic goal (provided the prerequisites of rating have been completed) within the appraisal scope in accordance with the following rules:	2.4 Generate Appraisal Results	2.4.1 Derive Findings and Rate Goals	
4.6.3.a	(A) Rate the goal "satisfied" when the associated generic or specific practices (or acceptable alternative practices) are judged to be implemented and the aggregate of weaknesses does not have a significant negative impact on goal achievement.	2.4 Generate Appraisal Results	2.4.1 Derive Findings and Rate Goals	

ARC ID	ARC Requirement	MDD Process	MDD Activity	Notes/Comments
4.6.3.b	(A) Rate the goal “unsatisfied” otherwise.	2.4 Generate Appraisal Results	2.4.1 Derive Findings and Rate Goals	
4.6.4	The method shall rate each process area within the appraisal scope, if requested by the appraisal sponsor, in accordance with the following rules:	2.4 Generate Appraisal Results	2.4.2a Determine Process Area Capability Level 2.4.2b Determine Satisfaction of Process Areas	
4.6.4.a	(A) For a staged representation, the process area is “satisfied” if and only if all of its specific and generic goals are rated “satisfied.”	2.4 Generate Appraisal Results	2.4.2b Determine Satisfaction of Process Areas	
4.6.4.b	(A) For a continuous representation, the process area is given a capability level rating based upon the highest level and all levels below for which its specific goals and the generic goals within the appraisal scope have been satisfied.	2.4 Generate Appraisal Results	2.4.2a Determine Process Area Capability Level	
4.6.4.c	(A) When a process area is determined to be outside of the organizational unit’s scope of work, the process area is designated as “not applicable” and is not rated.	2.4 Generate Appraisal Results	2.4.3a Determine Process Area Capability Profile 2.4.3b Determine Maturity Level	
4.6.4.d	(A) When a process area is outside of the appraisal scope, or if the associated findings do not meet the method’s defined criteria for data coverage, the process area is designated as “not rated” and is not rated.	2.4 Generate Appraisal Results	2.4.3a Determine Process Area Capability Profile 2.4.3b Determine Maturity Level	
4.6.5	The method shall rate the maturity level, if requested by the appraisal sponsor, in accordance with the following rules:	2.4 Generate Appraisal Results	2.4.3b Determine Maturity Level	
4.6.5.a	(A) A maturity level for a staged representation is achieved if all process areas within the level and within each lower level are either “satisfied” or “not applicable.”	2.4 Generate Appraisal Results	2.4.3b Determine Maturity Level	
4.6.5.b	(A) A maturity level for a continuous representation is achieved if the capability level profile is at or above the target profile for all process areas for that maturity level and all lower maturity levels in the equivalent staging, excepting those process areas that are designated as “not applicable.”	2.4 Generate Appraisal Results	2.4.3b Determine Maturity Level	
4.7	Reporting Results			

ARC ID	ARC Requirement	MDD Process	MDD Activity	Notes/Comments
4.7.1	(ABC) The method shall require documenting and reporting the appraisal findings and/or ratings to the appraisal sponsor and to the appraised organization.	3.1 Deliver Appraisal Results	3.1.1 Present Final Findings	
4.7.2	(A) If ISO/IEC 15504 conformance is desired, the method shall define a mechanism for converting objective evidence used by the appraisal team as the basis for goal ratings into associated process attribute outcomes in accordance with the translation requirement of ISO/IEC TR 15504-2 (clause 7.6).	TBD	TBD	A 15504 translation mechanism will be defined once a “demonstration of model compatibility document” has been published for the CMMI model.
4.7.3	(A) The method shall require the submission of appraisal data required by the CMMI Steward for the purpose of reporting aggregated appraisal information to the constituent community.	3.2 Package and Archive Appraisal Assets	3.2.3 Provide Appropriate Feedback to CMMI Steward	Specific requirements for submission of data to the CMMI Steward are defined by the SEI Lead Appraiser Program, as part of SCAMPI Lead Appraiser training and authorization.
4.7.4	(ABC) The method shall require that the appraisal record be provided to the appraisal sponsor for retention.	3.2 Package and Archive Appraisal Assets	3.2.2 Generate Appraisal Record	

References/Bibliography

- [AFMC 94]** AFMC Pamphlet 63-103, *Software Development Capability Evaluation (SDCE), Version 1.0*. United States Air Force Material Command (AFMC), 1994.
- [Byrnes 96]** Byrnes, P. & Phillips, M. *Software Capability Evaluation, Version 3.0, Method Description* (CMU/SEI-96-TR-002, ADA309160). Pittsburgh, PA: Software Engineering Institute, Carnegie Mellon University, 1996. <<http://www.sei.cmu.edu/publications/documents/96.reports/96.tr.002.html>>.
- [Dunaway 96]** Dunaway, D. K. *CMMsm-Based Appraisal for Internal Process Improvement (CBA IPI) Lead Assessor's Guide* (CMU/SEI-96-HB-003). Pittsburgh, PA: Software Engineering Institute, Carnegie Mellon University, 1996.
- [Dunaway 00]** Dunaway, D. K., Seow, M. L., & Baker, M. *Analysis of Lead Assessor Feedback for CBA IPI Assessments Conducted July 1998–October 1999* (CMU/SEI-2000-TR-005, ADA377438). Pittsburgh, PA: Software Engineering Institute, Carnegie Mellon University, 2000. <<http://www.sei.cmu.edu/publications/documents/00.reports/00tr005/00tr005title.html>>.
- [EIA 98b]** Electronic Industries Association. *Systems Engineering Capability Model, Part 2: EIA/IS-731-2 Appraisal Method*. Washington, D.C.: 1998. <<http://www.geia.org/sstc/prod01.htm>>.
- [Ibrahim 99]** Ibrahim, L., LaBruyere, L., Malpass, P., Marciniak, J., Salamon, A., & Weigl, P. *The Federal Aviation Administration Integrated Capability Maturity Model® (FAA-iCMM®) Appraisal Method (FAM), Version 1.0*. Federal Aviation Administration, 1999. <<http://www.faa.gov/aio/ProcessEngr/iCMM/index.htm>>.
- [ISO 98a]** International Organization for Standardization & International Electrotechnical Commission. *Information Technology: Software Proc-*

ess Assessment. Part 2, A Reference Model for Processes and Process Capability (ISO/IEC TR 15504-2:1998). Geneva, Switzerland: 1998.

- [ISO 98b]** International Organization for Standardization & International Electrotechnical Commission. *Information Technology: Software Process Assessment. Part 3, Performing an Assessment (ISO/IEC TR 15504-3:1998)*. Geneva, Switzerland: 1998.
- [ISO 98c]** International Organization for Standardization & International Electrotechnical Commission. *Information Technology: Software Process Assessment. Part 9, Vocabulary (ISO/IEC TR 15504-9:1998)*. Geneva, Switzerland: 1998.
- [SEI 01a]** CMMI Product Team. *Appraisal Requirements for CMMISM, Version 1.1*. (CMU/SEI-2001-TR-034). Pittsburgh, PA: Software Engineering Institute, Carnegie Mellon University, 2001.
- [SEI 01b]** CMMI Product Team. *CMMISM for Systems Engineering/Software Engineering, Version 1.1 Continuous Representation*. (CMU/SEI-2002-TR-001). Pittsburgh, PA: Software Engineering Institute, Carnegie Mellon University, 2001.
- [SEI 01c]** CMMI Product Team. *CMMISM for Systems Engineering/Software Engineering, Version 1.1 Staged Representation*. (CMU/SEI-2002-TR-002). Pittsburgh, PA: Software Engineering Institute, Carnegie Mellon University, 2001.
- [SEI 01c]** CMMI Product Team. *CMMISM for Systems Engineering/Software Engineering/Integrated Product and Process Development, Version 1.1 Continuous Representation*. (CMU/SEI-2002-TR-003). Pittsburgh, PA: Software Engineering Institute, Carnegie Mellon University, 2001.
- [SEI 01d]** CMMI Product Team. *CMMISM for Systems Engineering/Software Engineering/Integrated Product and Process Development, Version 1.1 Staged Representation*. (CMU/SEI-2002-TR-004). Pittsburgh, PA: Software Engineering Institute, Carnegie Mellon University, 2001.

Glossary

The MDD glossary defines many, but not all, terms used in this document. The following additional sources for terms and definitions should be considered supplementary to the MDD glossary:

- CMMI model glossary and terminology
- ARC glossary

Terms that are particularly significant to this document are duplicated from the model document or ARC for convenience.

accurate observation	An observation extracted from data collected during an appraisal that has been determined by the appraisal team to be (a) worded appropriately, (b) based on information seen or heard, (c) relevant to the appraisal reference model being used, (d) significant such that it can be classified as a strength, weakness, or alternative practice, and (e) not redundant with other observations. [ARC v1.1]
affirmation	An oral or written statement confirming or supporting implementation of a CMMI model specific practice or generic practice. Affirmations are usually provided by the implementers of the practice and/or internal or external customers, but may also include other stakeholders (e.g., managers, suppliers). [derived from MDD method overview] Interview responses are examples of face-to-face affirmations. Alternative forms of affirmations could include presentations or demonstrations of a tool or mechanism as it relates to implementation of a CMMI model practice. [derived from MDD PII appendix B]
alternative practice	A practice that is a substitute for one or more generic or specific practices contained in the CMMI model that achieves an equivalent effect toward satisfying the goal associated with the practices. Alternative practices are not necessarily one-for-one replacements for the generic or specific practices. [ARC v1.1 and CMMI model glossary]
appraisal	An examination of one or more processes by a trained team of professionals using an appraisal reference model as the basis for determining, as a minimum, strengths and weaknesses. [ARC v1.1]

Appraisal Disclosure Statement (ADS)	A summary statement describing the ratings generated as outputs of the appraisal, and the conditions and constraints under which the appraisal was performed. The ADS should be used for public disclosures of maturity level or capability level ratings so they can be interpreted accurately. [local]
appraisal findings	The results of an appraisal that identify the most important issues, problems, or opportunities for process improvement within the appraisal scope. Appraisal findings are inferences drawn from valid observations. [CMMI model glossary and ARC v1.1]
appraisal input	The collection of appraisal information required before data collection can commence. [ISO 98C and ARC v1.1]
appraisal method class	A family of appraisal methods that satisfy a defined subset of requirements in the Appraisal Requirements for CMMI (ARC). These classes are defined so as to align with typical usage modes of appraisal methods. [derived from ARC v1.0, CMMI model glossary and ARC v1.1]
appraisal modes of usage	The contexts in which an appraisal method might be utilized. Appraisal modes of usage identified for the SCAMPI method include internal process improvement, supplier selection, and process monitoring.
appraisal objectives	The desired outcome(s) of an appraisal process. [ARC v1.1]
appraisal output	All of the tangible results from an appraisal (see “appraisal record”). [ISO 98C and ARC v1.1]
appraisal participants	Members of the organizational unit who participate in providing information during the appraisal. [CMMI model glossary and ARC v1.1]
appraisal rating	The value assigned by an appraisal team to either (a) a CMMI goal or process area, (b) the capability level of a process area, or (c) the maturity level of an organizational unit. The rating is determined by enacting the defined rating process for the appraisal method being employed. [CMMI model glossary and ARC v1.1]
appraisal record	An orderly, documented collection of information that is pertinent to the appraisal and adds to the understanding and verification of

the appraisal findings and ratings generated. [derived from ISO 98C and ARC v1.1]

**appraisal
reference model**

The CMMI model to which an appraisal team correlates implemented process activities. [CMMI model glossary and ARC v1.1]

appraisal scope

The definition of the boundaries of the appraisal encompassing the organizational limits and the CMMI model limits within which the processes to be investigated operate. [derived from CMMI model glossary, ISO 98C and ARC v1.1]

appraisal sponsor

The individual, internal or external to the organization being appraised, who requires the appraisal to be performed, and provides financial or other resources to carry it out. [derived from ISO 98C and ARC v1.1]

appraisal tailoring

Selection of options within the appraisal method for use in a specific instance. The intent of tailoring is to assist an organization in aligning application of the method with its business needs and objectives. [CMMI model glossary and ARC v1.1]

**appraisal
team leader**

The person who leads the activities of an appraisal and has satisfied the qualification criteria for experience, knowledge, and skills defined by the appraisal method. [ARC v1.1]

artifact

A tangible form of objective evidence indicative of work being performed that is a direct or indirect result of implementing a CMMI model practice. (See “direct artifact” and “indirect artifact.”)

assessment

An appraisal that an organization does to and for itself for the purposes of process improvement. [ARC v1.1]

**capability
evaluation**

An appraisal by a trained team of professionals used as a discriminator to select suppliers, for contract monitoring, or for incentives. Evaluations are used to gain insight into the process capability of a supplier organization and are intended to help decision makers make better acquisition decisions, improve subcontractor performance, and provide insight to a purchasing organization. [ARC v1.1]

consensus

A method of decision making that allows team members to develop a common basis of understanding and develop general

agreement concerning a decision that all team members are willing to support. [ARC v1.1]

consolidation

The activity of collecting and summarizing the information provided into a manageable set of data to (a) determine the extent to which the data are corroborated and cover the areas being investigated, (b) determine the data's sufficiency for making judgments, and (c) revise the data-gathering plan as necessary to achieve this sufficiency. [ARC v1.1]

corroboration

The extent to which enough data has been gathered to confirm that an observation is acceptable for use by an appraisal team. [ARC v1.1] In SCAMPI, corroboration is obtained through method requirements for the collection of practice implementation indicators of multiple types (see "practice implementation indicator").

coverage

The extent to which objective evidence gathered addresses a model component within the scope of an appraisal. [ARC v1.1]

coverage criteria

The specific criterion that must be satisfied in order for coverage to be claimed. [ARC v1.1]

data collection session

An activity during which information that will later be used as the basis for observation formulation or corroboration is gathered. Data collection sessions (or activities) include the administration and/or analysis of instruments, document review, interviews, and presentations. [ARC v1.1]

direct artifact

The tangible outputs resulting directly from implementation of a specific or generic practice. An integral part of verifying practice implementation. May be explicitly stated or implied by the practice statement or associated informative material. [MDD method overview]

discovery-based appraisal

An appraisal in which limited objective evidence is provided by the appraised organization prior to the appraisal, and the appraisal team must probe and uncover a majority of the objective evidence necessary to obtain sufficient coverage of CMMI model practices. Discovery-based appraisals typically involve substantially greater appraisal team effort than verification-based appraisals, in which much of the objective evidence is provided by the appraised or-

ganization. (See verification-based appraisal for contrast.)

document	A collection of data, regardless of the medium on which it is recorded, that generally has permanence and can be read by humans or machines. [ARC v1.1] In SCAMPI, documents are work products reflecting the implementation of one or more model practices. This typically includes work products such as organizational policies, procedures, and implementation-level work products. Documents may be available in hardcopy, softcopy, or accessible via hyperlinks in a web-based environment. [derived from MDD method overview]
findings	The conclusions of an assessment, evaluation, audit, or review that identify the most important issues, problems, or opportunities within the appraisal scope. Findings include, at a minimum, strengths and weaknesses based on valid observations. [ARC v1.1]
focused investigation	A technique to prioritize appraisal team effort based on the continuous collection and consolidation of appraisal data, and monitoring of progress toward achieving sufficient coverage of CMMI model practices. Appraisal resources are targeted toward those areas for which further investigation is needed to collect additional data or verify the collected set of objective evidence. [derived from MDD method overview]
fully implemented (FI)	A practice characterization value assigned to a process instantiation when (1) direct artifacts are present and judged to be appropriate, (2) at least one indirect artifact and/or affirmation exists to confirm the implementation, and (3) no substantial weaknesses are noted. [MDD 3.7.2]
indirect artifact	An artifact that is a consequence of performing a specific or generic practice or that substantiate its implementation, but which is not the purpose for which the practice is performed. This indicator type is especially useful when there may be doubts about whether the intent of the practice has been met (e.g., a work product exists but there is no indication of where it came from, who worked to develop it, or how it is used). [MDD method overview]
instantiation	For practices implemented by projects, each project; for practices implemented organization-wide, the instance.

instruments	Artifacts used in an appraisal for the collection and presentation of data (e.g., questionnaires, organizational unit information packets). [ARC v1.1] In SCAMPI, instruments are used to collect written information relative to the organizational unit's implementation of CMMI model practices. This can include assets such as questionnaires, surveys, or an organizational mapping of CMMI model practices to its corresponding processes.
internal process improvement (IPI)	An appraisal mode of usage in which organizations appraise internal processes, generally to either baseline their process capability, to establish or update a process improvement program, or to measure progress in implementing such a program. [derived from MDD method overview]
interviews	A meeting of appraisal team members with appraisal participants for the purpose of gathering information relative to work processes in place. [ARC v1.1] In SCAMPI, this includes face-to-face interaction with those implementing or using the processes within the organizational unit. Interviews are typically held with various groups or individuals, such as project leaders, managers, and practitioners. A combination of formal and informal interviews may be held and interview scripts or exploratory questions developed to elicit the information needed.
largely implemented (LI)	A practice characterization value assigned to a process instantiation when (1) direct artifacts are present and judged to be appropriate, (2) at least one indirect artifact and/or affirmation exists to confirm the implementation, and (3) one or more weaknesses are noted. [MDD 3.7.2]
lead appraiser	A person who has achieved recognition from an authorizing body to perform as an appraisal team leader for a particular appraisal method. [ARC v1.1]
mini-team	See "process area mini-team."
not implemented (NI)	A practice characterization value assigned when the appraisal team determines insufficient objective evidence exists to state that the practice is implemented. That is, the criteria for assigning a value of Fully Implemented (FI), Largely Implemented (LI), or Partially

Implemented (PI) are not satisfied. [local]

objective evidence	<p>Qualitative or quantitative information, records, or statements of fact pertaining to the characteristics of an item or service or to the existence and implementation of a process element, which is based on observation, measurement, or test and which can be verified.</p> <p>[CMMI model glossary, ISO 98C and ARC v1.1] In SCAMPI, sources of objective evidence include instruments, presentations, documents, and interviews.</p>
observation	<p>A written record that represents the appraisal team members' understanding of information either seen or heard during the appraisal data collection activities. The written record may take the form of a statement or may take alternative forms as long as the information content is preserved. [CMMI model glossary , ARC v1.1]</p>
organizational unit	<p>That part of an organization that is the subject of an appraisal (also known as the organizational scope of the appraisal). An organizational unit deploys one or more processes that have a coherent process context and operates within a coherent set of business objectives. An organizational unit is typically part of a larger organization, although in a small organization, the organizational unit may be the whole organization. [Derived from CMMI model glossary, ISO 98C and ARC v1.1]</p>
partially implemented (PI)	<p>A practice characterization value assigned to a process instantiation when (1) direct artifacts are absent or judged to be inadequate, (2) artifacts or affirmations suggest that some aspects of the practice are implemented, and (3) weaknesses have been documented.</p> <p>[MDD 3.7.2]</p>
practice characterization	<p>The assignment of a value describing the extent to which a CMMI model practice is implemented, used as a mechanism to reach appraisal team consensus. The range of values for practice characterization values include Fully Implemented (FI), Largely Implemented (LI), Partially Implemented (PI), and Not Implemented (NI). Practice characterization values are assigned to each CMMI model practice for each process instantiation within the appraisal scope, and aggregated to the organizational unit level. [local]</p>

practice implementation indicator (PII)	An objective attribute or characteristic used as a “footprint” to verify the conduct of an activity or implementation of a CMMI model specific or generic practice. Types of practice implementation indicators include direct artifacts, indirect artifacts, and affirmations. [derived from 15504-9 and MDD method overview]
preliminary findings	Initial findings created by an appraisal team after consolidating and synthesizing valid observations to provide the findings to appraisal participants for validation of accuracy. [derived from ARC v1.1]
presentations	In SCAMPI, a source of objective evidence that includes information prepared by the organization and delivered visually or verbally to the appraisal team to aid in understanding the organizational processes and implementation of CMMI model practices. This typically includes such mechanisms as orientation or overview briefings, and demonstrations of tools or capabilities. [derived from MDD method overview]
process area mini-team	A subset of the appraisal team members, typically two or three, assigned primary responsibility for collection of sufficient appraisal data to ensure coverage of their assigned reference model process areas. [local]
process context	The set of factors documented in the appraisal input that influences the judgment and comparability of appraisal ratings. These include, but are not limited to, (a) the size of the organizational unit to be appraised, (b) the demographics of the organizational unit, (c) the application domain of the products or services, (d) the size, criticality, and complexity of the products or services, and (e) the quality characteristics of the products or services. [CMMI model glossary]
process monitoring	An appraisal mode of usage in which appraisals are used to monitor process implementation (for example, after contract award by serving as an input for an incentive/award fee decision or a risk management plan). The appraisal results are used to help the sponsoring organization tailor its contract or process monitoring efforts by allowing it to prioritize efforts based on the observed strengths and weaknesses of the organization’s processes. This usage mode focuses on a long-term teaming relationship between the sponsoring organization and the development organization (buyer and

supplier). [derived from MDD method overview]

process profile	The set of goal ratings assigned to the process areas in the scope of the appraisal. In CMMI, also known as the process area profile. [derived from ISO98c and ARC v1.1]
rating	(See “appraisal rating.”) [CMMI model glossary and ARC v1.1]
satisfied	Rating given to a goal when the aggregate of valid observations and associated findings does not negatively impact achievement of the goal. Rating given to a process area when all of its goals are rated “satisfied.” [ARC v1.1]
strength	Exemplary or noteworthy implementation of a CMMI model practice. [CMMI model glossary and ARC v1.1]
sufficient data coverage	A determination that the coverage requirements have been met. See “coverage” and “coverage criteria.” [ARC v1.1]
supplier selection	An appraisal mode of usage in which appraisal results are used as a high value discriminator to select suppliers. The results are used in characterizing the process-related risk of awarding a contract to a supplier. [derived from MDD method overview]
tailoring	See “appraisal tailoring.” [ARC v1.1]
valid observation	An observation that the appraisal team members agree is (a) accurate, (b) corroborated, and (c) consistent with other valid observations. [ARC v1.1]
verification-based appraisal	An appraisal in which the focus of the appraisal team is on verifying the set of objective evidence provided by the appraised organization in advance of the appraisal, in order to reduce the amount of probing and discovery of objective evidence during the appraisal on-site period. (See discovery-based appraisal for contrast.)
weakness	The ineffective, or lack of, implementation of one or more CMMI model practices. [CMMI model glossary and ARC v1.1]

REPORT DOCUMENTATION PAGE			<i>Form Approved OMB No. 0704-0188</i>
Public reporting burden for this collection of information is estimated to average 1 hour per response, including the time for reviewing instructions, searching existing data sources, gathering and maintaining the data needed, and completing and reviewing the collection of information. Send comments regarding this burden estimate or any other aspect of this collection of information, including suggestions for reducing this burden, to Washington Headquarters Services, Directorate for Information Operations and Reports, 1215 Jefferson Davis Highway, Suite 1204, Arlington, VA 22202-4302, and to the Office of Management and Budget, Paperwork Reduction Project (0704-0188), Washington, DC 20503.			
1. AGENCY USE ONLY (Leave Blank)	2. REPORT DATE December 2001	3. REPORT TYPE AND DATES COVERED Final	
4. TITLE AND SUBTITLE Standard CMMI Appraisal Method for Process Improvement (SCAMPI), Version 1.1: Method Definition Document		5. FUNDING NUMBERS F19628-00-C-0003	
6. AUTHOR(S) Members of the Assessment Method Integrated Team			
7. PERFORMING ORGANIZATION NAME(S) AND ADDRESS(ES) Software Engineering Institute Carnegie Mellon University Pittsburgh, PA 15213		8. PERFORMING ORGANIZATION REPORT NUMBER CMU/SEI-2001-HB-001	
9. SPONSORING/MONITORING AGENCY NAME(S) AND ADDRESS(ES) HQ ESC/XPK 5 Eglin Street Hanscom AFB, MA 01731-2116		10. SPONSORING/MONITORING AGENCY REPORT NUMBER	
11. SUPPLEMENTARY NOTES			
12A DISTRIBUTION/AVAILABILITY STATEMENT Unclassified/Unlimited, DTIC, NTIS		12B DISTRIBUTION CODE	
13. ABSTRACT (MAXIMUM 200 WORDS) The Standard CMMI Appraisal Method for Process Improvement (SCAMPI SM) is designed to provide benchmark quality ratings relative to Capability Maturity Model [®] Integration (CMMI SM) models. It is applicable to a wide range of appraisal usage modes, including both internal process improvement and external capability determinations. SCAMPI satisfies all of the Appraisal Requirements for CMMI (ARC) requirements for a Class A appraisal method and can support the conduct of ISO/IEC 15504 assessments. The SCAMPI Method Definition Document describes the requirements, activities, and practices associated with each of the processes that compose the SCAMPI method. It is intended to be one of the elements of the infrastructure within which SCAMPI Lead Appraisers conduct a SCAMPI appraisal. Precise listings of required practices, parameters, and variation limits, as well as optional practices and guidance for enacting the method, are covered. An overview of the method's context, concepts, and architecture is also provided.			
14. SUBJECT TERMS appraisal, CMMI, MDD, appraisal requirements, Class A method		15. NUMBER OF PAGES 244	
16. PRICE CODE			
17. SECURITY CLASSIFICATION OF REPORT Unclassified	18. SECURITY CLASSIFICATION OF THIS PAGE Unclassified	19. SECURITY CLASSIFICATION OF ABSTRACT Unclassified	20. LIMITATION OF ABSTRACT UL

NSN 7540-01-280-5500

Standard Form 298 (Rev. 2-89) Prescribed by ANSI Std. Z39-18 298-102

[®] Capability Maturity Model is registered in the U.S. Patent and Trademark Office.

SM SCAMPI, CMMI, and CMM Integration are service marks of Carnegie Mellon University.